

AN ASSESSMENT OF INFORMATION TECHNOLOGY CURRICULUM
IMPLEMENTATION IN VOCATIONAL HIGH SCHOOLS IN ANKARA

A THESIS SUBMITTED TO
THE GRADUATE SCHOOL OF SOCIAL SCIENCES
OF
MIDDLE EAST TECHNICAL UNIVERSITY

BY

KADER BİÇER

IN PARTIAL FULFILLMENT OF THE REQUIREMENTS
FOR
THE DEGREE OF MASTER OF SCIENCE
IN
THE DEPARTMENT OF EDUCATIONAL SCIENCES

FEBRUARY 2009

Approval of the Graduate School of Social Sciences

Prof. Dr. Sencer Ayata
Director

I certify that this thesis satisfies all the requirements as a thesis for the degree of Master of Science.

Assoc. Prof. Dr. Oya Yerin Güneri
Director

This is to certify that we have read this thesis and that in our opinion it is fully adequate, in scope and quality, as a thesis for the degree of Master of Science.

Assoc. Prof. Dr. Ercan KIRAZ
Supervisor

Examining Committee Members

Prof. Dr. Hasan Şimşek (METU, EDS) _____
Assoc. Prof. Dr. Ercan KIRAZ (METU, EDS) _____
Assoc. Prof. Dr. Ayhan ERDEM (GAZİ, TEF) _____

I hereby declare that all information in this document has been obtained and presented in accordance with academic rules and ethical conduct. I also declare that, as required by these rules and conduct, I have fully cited and referenced all material and results that are not original to this work.

Name, Last name : Kader Biçer

Signature :

ABSTRACT

AN ASSESSMENT OF INFORMATION TECHNOLOGY CURRICULUM IMPLEMENTATION IN VOCATIONAL HIGH SCHOOLS

Biçer, Kader

M.S., Department of Educational Sciences

Supervisor: Assoc. Prof. Dr. Ercan Kiraz

February 2009, 196 pages

This study aims to provide a general picture of newly adopted IT program in vocational high schools. Through this aim, the issues of to what extent are the objectives and content of Vocational high schools' new IT curriculum satisfied the needs, how it is implemented in schools, how it is practiced under different circumstances and which factors influence its implementation process are examined. This study was designed as a formative evaluation based on CIPP Model-Process Evaluation. In order to grasp perceptions of vocational high school IT teachers and 11th grade IT area students' two self-reported questionnaires were developed by the researcher. The sample constituted of 683 Grade 11 students and 83 IT teachers from 28 vocational high schools in the 7 urban district of Ankara. Heavily, descriptive and statistics and quantitative data analysis techniques were utilized to analyze the data however in some parts, inferential statistics were also employed.

Results of the study indicated that the objectives of the new IT program are responsive to the local, national and global IT sector and catching the demanded skills in the world of work. Moreover it is determined that the new program supports flexibility in principle however in action there are some obstacles those barriers the adequately functioning of the new program. Therefore, this study also attempts to reveal the problems related to students, teachers, schools quality indicators and program modules in order to supply the deficiencies in the early

stages of program implementation.

Keywords: Information technologies program, Modular curriculum, Vocational high schools, Curriculum development in VET, Curriculum evaluation in VET

ÖZ

MESLEK LİSELERİ BİLİŞİM TEKNOLOJİLERİ PROGRAMININ UYGULAMA SÜRECİNİN DEĞERLENDİRİLMESİ

Biçer, Kader

Yüksek Lisans, Eğitim Bilimleri Bölümü

Tez Yöneticisi: Doç. Dr. Ercan Kiraz

Şubat 2009, 196 sayfa

Bu çalışmanın amacı yeni uygulamaya konulan meslek liseleri bilişim teknolojileri programını genel bir çerçevede ele almaktır. Bu doğrultuda, program amaçları ve içeriğinin gereksinimlere cevap verme ve temel ilkelerine uygun olarak uygulanma durumu ile bu süreci etkileyen faktörlerin neler olduğu incelenmiştir. Çalışma ‘CIPP model-süreç değerlendirme’ ni esas alan biçimlendirici değerlendirmedir. Meslek liseleri bilişim teknolojileri öğretmenlerinin ve onbirinci sınıf bilişim teknolojileri alanı öğrencilerinin bu konudaki algılarını anlamak için araştırmacı tarafından geliştirilen iki anket kullanılmıştır. Ankara ilinin merkez yedi ilçesinde bulunan 28 meslek lisesinden seçilen 683 bilişim teknolojileri onbirinci sınıf öğrencisi ve 83 bilişim teknolojileri öğretmeni araştırmanın örneklemini oluşturmuştur. Ağırlıklı olarak elde edilen veriler betimleyici istatistiksel yöntemler ve nicel veri analizi teknikleri kullanılarak analiz edilmiştir. Ayrıca bazı bölümlerde yordayıcı istatistiksel yöntemlere de başvurulmuştur.

Araştırmanın sonuçları yeni bilişim teknolojileri programı amaçlarının yerel, ulusal ve küresel bilişim sektörünün ihtiyaçlarına cevap verdiği ve çalışma hayatında gereksinim duyulan becerileri kapsadığını göstermektedir. Diğer yandan, yeni programın ilkesel olarak esnekliği desteklediği ancak uygulamada programın tam olarak işlemlerini engelleyen sorunlar olduğu saptanmıştır. Bu nedenle, çalışma aynı zamanda öğrenciler, öğretmenler, okul kalite göstergeleri ve

program modülleri ile ilgili bu problemleri, uygulamanın erken aşamasında açığa çıkarmayı hedeflemiştir.

Anahtar Kelimeler: Bilişim teknolojileri programı, Modüler müfredat, Meslek Liseleri, Mesleki eğitimde program geliştirme, Mesleki eğitimde program değerlendirme

To Ada

ACKNOWLEDGMENTS

I thank my advisor Assoc. Prof. Dr. Ercan Kiraz for his guidance, expertise, and patience throughout this research. With his support, this study has been an invaluable learning experience for me. It has really been an honour to work with this consummate professional.

I'm also grateful for the insights and efforts put forth by the examining committee, Assoc. Prof. Dr. Ayhan Erdem, and Prof. Dr. Hasan Şimşek.

It may be unusual to thank an institution; nevertheless I feel the need to thank Middle East Technical University for providing such an excellent environment for self-development. I am very grateful to the people who built this splendid institution and put their efforts as members over the years.

I also would like to express my special thanks to my friends Duygu Ören and Erkan Vural for their morale support.

Finally, I would like to express my deepest gratitude to all members of my family, especially my mother Şerife Yüksel, my husband Veli Biçer and my little daughter Ada Gül Biçer for their love, understanding, and patience.

TABLE OF CONTENTS

PLAGIARISM.....	iii
ABSTRACT	iv
ÖZ	vi
DEDICATION.....	viii
ACKNOWLEDGMENTS.....	ix
TABLE OF CONTENTS	x
LIST OF TABLES	xiv
LIST OF FIGURES.....	xvi
LIST OF ABBREVIATIONS	xviii
CHAPTERS	
1.INTRODUCTION.....	1
1.1. Background to the Study	1
1.2. Purpose of the Study	3
1.3. Significance of the Study	6
1.4. Definition of Terms	6
2.REVIEW OF LITERATURE.....	8
2.1. Vocational Education Concept and Perspectives in the World.....	9
2.2. Education System in Turkey	12
2.2.1. Formal Education	13
2.2.2. Non-Formal Education.....	14
2.3. Development of Vocational-Technical Education in Turkey.....	15
2.3.1. Historical Background.....	15

2.3.2. The Recent Organization of Formal Initial Level Vocational Education System	21
2.4. Rationale of Change for the Formal Initial Level Vocational education system	26
2.4.1. Centralized education system.....	29
2.4.2. Ineffective Vocational Curricula	29
2.4.3. Inflexibility of System.....	30
2.4.4. Incompatible Educational Methodology	31
2.4.5. Insufficient Vocational Counselling.....	31
2.4.6. Limited Transition to Undergraduate Programs.....	32
2.4.7. Incompetent Vocational Teachers	32
2.5. Vocational and Technical Education Curriculum	33
2.5.1. Characteristics of VET curriculum	38
2.5.2. Curriculum Development in VET	40
2.5.3. Competency-Based Modular VET Curriculum.....	47
2.5.4. Modularization of Instruction.....	50
2.5.5. Implementation of Competency-Based Modular VET Curricula in Vocational High Schools in Turkey	53
2.5.6. Curriculum Evaluation in VET	63
2.5.7. Vocational Schools IT Curriculum in Turkey	66
2.6. Research Studies on Vocational Program Evaluation.....	69
3.METHOD.....	72
3.1. Overall Research Design.....	72
3.2. Research Questions	74

3.3. Population.....	75
3.4. Data Analysis and Instruments	77
3.4.1. Teachers' Questionnaire.....	77
3.4.2. Students' Questionnaire	78
3.4.3. Validity and Reliability of Instruments.....	79
3.5. Limitations of the Study	79
4.RESULTS.....	81
4.1. Demographic Information of Subjects	81
4.2. The objectives and content of IT curriculum in relation to labour market	84
4.2.1. Global IT sector.....	84
4.2.2. National IT sector.....	90
4.2.3. Local IT sector and community	92
4.3. Flexibility of IT curriculum.....	96
4.3.1. Program Flexibility	96
4.3.2. Individual Flexibility.....	103
4.3.3. Presentation Flexibility	107
4.3.4. Educational Route Flexibility.....	119
4.4. Educational Settings of IT curriculum	122
4.4.1. Students	122
4.4.2. Teachers	126
4.4.3. School quality indicators.....	131
4.4.4. Modules.....	136
4.4.5. Problems faced during instruction.....	144
5.CONCLUSIONS AND IMPLICATIONS	147

5.5. Conclusions	147
5.5.1. Demands of IT labour market	147
5.5.2. Adaptability of IT curriculum	148
5.5.3. Appropriateness of educational settings.....	152
5.6. Implications for Teaching and Learning	156
5.7. Implications for Future Research	159
REFERENCES	160
APPENDICES.....	168
Appendix A:Framework IT program for Vocational High Schools.....	168
Appendix B: Framework IT program for Anatolian Vocational High Schools	169
Appendix C : Framework IT program for Technical High Schools	170
Appendix D : Framework IT program for Anatolian Technical High Schools	171
Appendix E : Training Standard of Computer Technical Service	172
Appendix F : Training Standard of Web Programming.....	174
Appendix G : Training Standard of Database Programming	176
Appendix H : Training Standard of Network Management.....	178
Appendix I : Teachers Questionnaire (Turkish).....	180
Appendix J : Teachers Questionnaire (English).....	186
Appendix K: Students Questionnaire (Turkish).....	192
Appendix L : Students Questionnaire (English)	194
Appendix M: Curriculum Vitae	196

LIST OF TABLES

Table 1. <i>Number of Students, Schools and Teachers in High Schools in 2007</i>	27
Table 2. <i>Subjects of the Study (district)</i>	76
Table 3. <i>Subjects of the Study (district)</i>	77
Table 4. <i>Demographic Distributions of Students</i>	82
Table 5. <i>Demographic Distributions of Teachers</i>	83
Table 6. <i>Frequency distribution of teachers on global IT sector</i>	85
Table 7. <i>Descriptive statistics of item 1, 2 and 3</i>	87
Table 8. <i>Descriptive statistics of item 4, 5 and 6</i>	88
Table 9. <i>Teachers' perspectives on content by General Directorate of the School</i>	89
Table 10. <i>Descriptive statistics of teachers on national IT sector</i>	91
Table 11. <i>Descriptive statistics of teachers on local IT sector</i>	93
Table 12. <i>Teachers' perspectives by General Directorate of the School</i>	95
Table 13. <i>Descriptive statistics of teachers on program flexibility</i>	99
Table 14. <i>Teachers' perspectives on program flexibility by attendance at in-service training programs</i>	101
Table 15. <i>Descriptive statistics of teachers and students on individual flexibility</i>	104
Table 16. <i>Descriptive statistics of teachers on presentation flexibility</i>	108
Table 17. <i>Descriptive statistics of teaching methods and approaches</i>	110
Table 18. <i>Descriptive statistics of assessment and measurement techniques</i>	112

Table 19. <i>Descriptive statistics of students on presentation flexibility</i>	115
Table 20. <i>Students' perspectives on presentation flexibility by type of the school</i>	117
Table 21. <i>Descriptive statistics of teachers on educational route flexibility</i>	120
Table 22. <i>Frequency distribution of teachers on students</i>	123
Table 23. <i>Descriptive statistics of students on learning new program</i>	125
Table 24. <i>Descriptive statistics of teachers on teaching new program</i>	127
Table 25. <i>Frequency distributions of teachers on attendance at in-service training</i>	129
Table 26. <i>Frequency distributions of teachers on evaluation of in-service training</i>	130
Table 27. <i>Descriptive statistics of teachers on school quality indicator</i>	132
Table 28. <i>Teachers' perspectives on school quality indicators by General Directorate of the School</i>	134
Table 29. <i>Frequency distribution of students on school quality indicators</i>	135
Table 30. <i>Descriptive statistics of teachers on modules functional linkages</i>	137
Table 31. <i>Descriptive statistics of teachers on modules</i>	139
Table 32. <i>Descriptive statistics of teachers on modules' offers</i>	141
Table 33. <i>Descriptive statistics of students on modules</i>	141
Table 34. <i>Descriptive statistics of Problems faced during instruction</i>	144

LIST OF FIGURES

<i>Figure 1.</i> Overview of Vocational Education and Training and related concepts ...	8
<i>Figure 2.</i> Schematic presentation of the Turkish educational system.....	15
<i>Figure 3.</i> Transition to Higher education.....	20
<i>Figure 4.</i> MoNE framework.....	22
<i>Figure 5.</i> Schematic presentation of the vocational pathways in Turkey	23
<i>Figure 6.</i> Newly Organizational Structures of Vocational High Schools.....	24
<i>Figure 7.</i> Goals of Education	37
<i>Figure 8.</i> Vocational Program System.....	42
<i>Figure 9.</i> The Instructional Systems Development Model	43
<i>Figure 10</i> Training Technology System	45
<i>Figure 11.</i> A Teaching-Learning System.....	47
<i>Figure 12 .</i> The ibstpi Competency Development Model.....	50
<i>Figure 13.</i> Modularization of Instruction.....	51
<i>Figure 14.</i> Periodic activities of curriculum development.....	53
<i>Figure 15.</i> Schema of VET system elements.....	55
<i>Figure 16.</i> 8 Level NQF of Turkey	56
<i>Figure 17.</i> The Objectives of VET system	58
<i>Figure 18.</i> Teaching Learning Process	60
<i>Figure 19.</i> A Framework for curriculum evaluation.....	64
<i>Figure 20.</i> Overall Design of the Study	73
<i>Figure 21.</i> Frequency of item 1	86
<i>Figure 22.</i> Frequency of item 1.....	91

<i>Figure 23.</i> Frequency of item 1	94
<i>Figure 24.</i> Frequency of item 2	94
<i>Figure 25.</i> Frequency of item 1	97
<i>Figure 26.</i> Frequency of item 2	98
<i>Figure 27.</i> Frequency of item 1	105
<i>Figure 28.</i> Frequency of item 7	106
<i>Figure 29.</i> Frequency of item 1	109
<i>Figure 30.</i> Frequency of item 2	109
<i>Figure 31.</i> Frequency of item 1	121
<i>Figure 32.</i> Frequency of item 2	121
<i>Figure 33.</i> Frequency of item 1	124
<i>Figure 34.</i> Frequency of item 2	124
<i>Figure 35.</i> Frequency of item 8	129

LIST OF ABBREVIATIONS

MoNE	:Ministry of National Education
MEB	:Milli Eğitim Bakanlığı
VET	:Vocational Education and Training
MEGEP	:Mesleki Eğitim ve Öğretim Sisteminin Güçlendirilmesi Projesi
SVET	:Strengthening the Vocational Education and Training System in Turkey
IT	:Information Technologies
OECD	:Organisation for Economic Co-operation and Development
CQAF	:Common Quality Assurance Framework
ÖSS	:Öğrenci Seçme Sınavı (Student Selection Examination)
ÖSYM	:Öğrenci Seçme ve Yerleştirme Merkezi (Student Selection and Placement Centre)
YÖK	:Yükseköğretim Kurulu (Higher Education Board)
DG	:General Directorate
TESK	:Türkiye Esnaf ve Sanatkarları Konfederasyonu (The Turkish Confederation of Tradesmen and Craftsmen)
SURA	:Turkish National Education Council
ETF	:European Training Foundation
Ibstpi	:International Board of Standards for Training, Performance and Instruction
CBE	:Competency Based Education
OS	:Occupational Standards
TS	:Training Standards
MSK	:Meslek Standartları Komisyonu (Training Standards Commission)
NQS	:National Qualification System
Metargem	: Meslekî ve Teknik Eğitim Araştırma ve Geliştirme Merkezi (Vocational and Technical Education Research and Development Centre)
ITTAA	:Information Technology Association of America

CHAPTER 1

INTRODUCTION

1.1. Background to the Study

Vocational education and training (VET) is one of the most controversial topics in all modern countries of the world today. This can be itemized by two reasons: Economical and social. Considering today's knowledge-based economies, there is a strong correlation between the technological advances and the place of a country in competitive world market (Ashton & Green, 1996). The growth of a country mostly depends on the success of setting up the necessary skills in its labour force for utilizing the high technology. This promotes the employability of its citizens and paves the way to the enlargement of its human resources from an economical point of view. More importantly, VET is a significant topic as a social policy, since it is a crucial part of the lifelong learning of the individuals who gain the required skills to be used in their work-lives. This increases the social inclusion of the individuals; and these individuals, then, form the wealth and prosperity of the nations. This is also due to the fact that one of the major differences between the developed and poor countries results from the quality of the education of the people in accordance with the vision and economical background of the country (Middleton, Ziderman, & Van Adams, 1993). Therefore, many countries in the world apply their own VET systems and policies in order to equip their citizens with the required skills and knowledge of the work-life and to ease their transition from education into society. And as a result every central government concerned with the matching of manpower to drive for economic growth.

Up to now, VET has been facilitated to solve particular issues specified as the objectives of the education policies. In common sense, vocationalism of education derives its purpose and rationale from economic needs and requirements (Skilbeck, 1994). Thereby, VET is used to help young population in finding jobs easily; to

enable a nation-wide adoption to the technological achievements; to train middle level technicians with different skills; and create a labour force for the needs of the society with the help of the education system(Psacharopoulos, 1997).

Recent changes in terms of globalization, ever-increasing pace of the technological developments and growing need to the well-educated individuals affects the attitude towards VET in all over the world. The importance of comparability and transparency of credentialed knowledge and skills across national boundaries increased as well as improving the quality of VET systems in Europe (OECD, 1992). Thus, VET systems began to evolve in Turkey, and more generally in Europe, within the scope of Copenhagen process. The Copenhagen process, in fact, is a coordinated action to strengthen the European dimension in VET with the aim of improving closer cooperation among the member and candidate states to achieve European-level main priorities. These main priorities can be stated as the promotion of mobility and inter-institutional partnerships, identification of the European best practices in VET, achieving the transparency of VET systems among the countries, and recognition of competences and qualifications between the different countries and at different levels. Besides these priorities, one of the most important results of the Copenhagen process is to act as *a trigger effect* in many countries, including Turkey, to reshape their VET systems in order to meet the quality assurance criteria specified in the Common Quality Assurance Framework (CQAF). This reshaping process enables the countries to consider the recent developments and ideas in VET and adopt them to meet the countries' needs.

Although the VET system in Turkey has been evolving over years to increase the quality of the workforce, the most important steps to create a modern VET approach has been taken in recently years within the scope of SVET (Strengthening the Vocational Education and Training System in Turkey) project. SVET is partially supported by Copenhagen process and a five-year project resulting from an agreement signed between the European Commission and the Government of Turkey in 30 September 2002. The project finds itself at the centre of a debate about the relationship (actual and desired) between labour market and education; of another debate about central, provincial and local responsibilities;

and of a third debate about the likely career path of VET graduates (MEB-MEGEP, 2006). It aims to provide competency-based modular curricula to support a flexible and high quality VET system and train blue-collar workforce. Within this scope, a great amount of change has been conducted on curricula of vocational high schools. This also includes adopting a new certificate system, and also a flexible education policy to consider the requirements of industry. To achieve this, the governing bodies provide a set of educational standards to utilize a range of skills in various occupational areas (e.g. Information Technologies, Textiles, Electronics, etc.).

One of these areas is Information Technologies, which has become of the most robust industries in the world because of its role as a key driver of productivity and global economic growth. The main focus of this thesis is newly adopted IT curriculum of vocational high schools in terms of its content and approach. It is constituted of four main occupational profiles: computer technical service, network management, database programming and web programming. Students both master the common skills of IT area and specific skills of an IT occupational profile as well during the four years of vocational high school education.

1.2. Purpose of the Study

As a result of the restructuring activities in Turkish VET system, the VET curriculum, and accordingly IT curriculum, of vocational high schools is modernized in 2005 in order to meet the socio-economic needs of the country and to conform more to the principles of life-long learning. This modernization process includes significant changes compared to the previous curricula in terms of the system structure (i.e. centralized vs. decentralized), educational methodology (i.e. teacher-centred vs. student-centred), flexibility (i.e. nation-wide fixed vs. locally variable) and effectiveness (i.e. entry job skills vs. life-long learning). Although these major changes aim to achieve unique objectives such as promoting quality in individuals' skills and establishing school-industry connection, there still exist some obstacles in the implementation due to the deficiencies in the infrastructure and misinterpretations in its various stages.

One of the goals of this thesis is, therefore, to provide a better insight into how the

new IT curriculum of vocational high schools is implemented in schools by analyzing the circumstances in its practice and determining the factors that influence its implementation process. In this scope, the following research questions are identified to capture the major focus of this thesis:

Research Question 1: *To what extent are the objectives and content of Vocational high schools' new IT curriculum fulfilled the needs of IT labour market?*

Basically, the vocational high school graduates face two options when they finish their education. One of these options is to pursue a degree by attending a program of a higher education institution. Despite the recent regulations to achieve a smooth transition to an higher degree, recent studies shows that the percentage of the students to enrol to higher education is quite low (only 27% of all vocational high school graduates) (Eşme, 2007). The remaining majority, however, is mostly trained to work at the technician level in relevant industry sectors.

In the light of this fact, the demands of IT labour market constitute a big influence on the newly adopted IT curriculum. In particular, industry requires graduates not only to master on entry-level basic skills, but also to obtain comprehensive skills to success in the adaptability to the work environment or to achieve a continuous development as a life-long learning. Additionally, it is also aimed to attain the transferability of the work force in an international context. These requirements are highly reflected in the new curriculum as a primary objective. Within the scope of this research question, it is, therefore, aimed to assess to what extent this is achieved in the implementation of the curriculum.

Research Question 2: *To what extent is the flexibility (program adaptation) actualized in execution of Vocational high schools' new IT curriculum?*

The new IT curriculum is designed to be a competency-based, modular framework in order to enable both the decentralization of program implementation and the transferability and assessment of individuals based on their competencies. The main motivation of introducing such a framework is to attain some degree of flexibility in its execution. This flexibility is expected to achieve when the school administrators and teachers locally adapt the curriculum according to the needs of the industry in particular regions, and accordingly when the students are allowed to

select among the courses up to their competencies and abilities.

This unique objective poses some new requirements and difficulties to its actors. Instead of a take-it-and-use-it curriculum, the administrators and teachers are supposed to conduct local changes in collaboration with the industry partners for the adaptation of the program. Additionally, students should be well informed about the modules and the competencies and be allowed to choose specific pathways during their vocational education. Therefore, in this research question, it is specifically aimed to determine to what extent this flexibility is achieved in vocational high schools.

Research Question 3: *To what extent are the educational settings suitable for to be implementation of the Vocational high schools new IT curriculum in the way it is intended?*

In addition to the structural changes in the new IT curriculum, one of the most significant changes is foreseen in terms of the education methodology. Unlike the previous traditional teacher-centred approaches, the new curriculum is built based on the student-centred, constructivist, active-learning methodology. The application of this newly designed methodology in such an educational setting, which was previously used for traditional approaches over the years, presents some obstacles to its success. Specifically, the student-centred, constructivist approaches need to be supported with a solid infrastructure to foster independent (and guided) learning. Moreover, in-service training of the vocational teachers and counselling support is critical to create awareness about this methodological change. In order to assess the situation in the vocational high schools, this research question aims to find out the suitability of the educational setting in schools to the new curriculum.

Based on these three research questions, this study is mostly dependent on beliefs and perceptions of vocational school teachers and students of IT program. The major points of focus in this evaluation will be curriculum content, goals, teaching methods and techniques, the instructional materials used during lessons, the physical structure and facilities of the schools, and local, school and classroom level factors that influence the process of curriculum implementation. Therefore,

the aim of my evaluation is to ensure whether the program's important characteristics are enabled to be implemented and to identify the deficiencies, if any, in this implementation. In the long run, it also aims to determine the points to introduce improvements in the organization, activities and materials of the program (Finch & Crunkilton, 1989).

1.3. Significance of the Study

The new competency based modular vocational high schools IT program is completely different in terms of its structure, progress and content comparing with the old one. According to the new perceptive all types of vocational high schools are responsible to adapt the common framework program up to their circumstances. New vocational high schools' IT program began implementation in 2004-2005 academic year and the first students have not graduated yet. Therefore the program will be evaluated with the intention of early determination of deficiencies in program implementation. And in this evaluation the focus is not only develop the program, but also to conceptualize what the program is and how it works (Fitz-Gibbon & Morris, 1987).

1.4. Definition of Terms

Vocational education: Which is mainly designed to lead participants to a deeper understanding of a subject or group of subjects and to acquire the practical skills, know-how, and understanding necessary for employment in a particular occupation or trade or class of occupations or trades (Moodie, 2002).

Vocational High Schools: Vocational high schools provide students 4-year education on occupational skills and general academic knowledge. They prepare students for higher education or support them for mastering a job simultaneously (MEB, 2007b).

Information Technologies: The term used to describe computer hardware and software which are used "to access and retrieve information, and store, organize, manipulate and present" it by electronic means (UNESCO, 2003).

Information Technologies Program: Information technologies program has been published by the decision of Board of Education numbered 324 in 07.09.2005 and

began implementation in the academic year 2005-2006, in vocational high schools. The general objective of the program is: Training blue-colour employee for predetermined occupational profiles whose qualifications meet the needs IT sector and, scientific and technologic developments. It has four departments: Computer technical service, Network management, Web programming and Database programming (MEB-MEGEP, 2007a).

Flexibility: Flexibility is used as an attribute of various types of systems. Flexibility has been defined differently in many fields of engineering, architecture, biology, economics, etc. In the context of educational design one can define flexibility as the ability of a system to respond to potential innovations in technology and science; changing demands of industry and individual students' needs ("Wikipedia ").

CHAPTER 2

REVIEW OF LITERATURE

In this section, we outline the concepts that explicitly or implicitly affect the vocational education in the world, and also specifically in Turkey. As depicted in *Figure 1*, the significance of Vocational Education and Training (VET) mostly influenced by the recent developments in the service economy that dominantly takes place in the world of business. In particular, the competent and customer-centred logic of service economy increases the pressure on the work force to obtain certain knowledge and skills. Although the enterprises already utilize competency-based programs to educate their employees, the vast of needs on this particular subject also affects the education systems of many countries. Thus, the VET curriculum in the world started to reshape its structure towards a more competency-based and industry-oriented scheme.

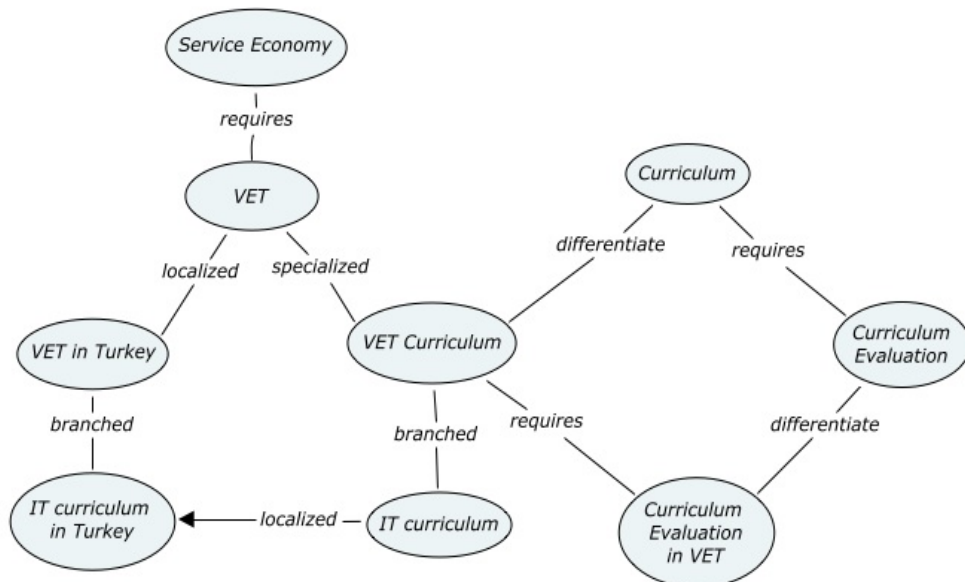

Figure 1. Overview of Vocational Education and Training and related concepts

With these ideas in mind, Turkish secondary level vocational education system reshaped and vocational high schools has begun to implement new competency-based modular curricula in the schooling year 2005-2006.

First of all, vocational education concepts in the world and in our country will be discussed as initial topics of this section. Then, we will briefly summarize vocational education system and its historical development in Turkey. Additionally, we present an overview of curriculum and particularly VET curriculum development and evaluation approaches that exist in the world today. More importantly, since our focus in this thesis is the vocational Information Technologies curriculum, we also narrow the subject to the IT development in Turkey and present its internal structure in detail. Furthermore, throughout the text, we discuss the shortcomings of the previous approaches with the objectives of the new curriculum. We consider that these findings constitute the basis in order to shape the research presented in the subsequent sections.

2.1. Vocational Education Concept and Perspectives in the World

The term vocationalism is defined as efforts in the schools to include practical subjects in the curriculum with the intention of generating basic skills and knowledge that can get the individuals ready for an occupation (Lauglo & Lillis, 1988). In this regard, vocational education is defined as the orientation of education for the preparation to the labour markets (Grubb, 1985). This type of education can be considered as the development process of an individual in all mental, emotional, social and economical viewpoints by training on occupational knowledge, skills and practical competencies needed for individual and communal life (Alkan, Doğan, & Sezgin, 2001). Olkun (1995), states this preparation of individuals for their future life as the general objective of vocational education. As a result of mastering the occupational skills during their education, the young population gets easy opportunities in finding jobs and also experience a smooth transition into the social community. In this way unemployed people is protected against destructive habits and activities for the benefit of both themselves and the community (Psacharopoulos, 1997).

Furthermore, vocational education does not only satisfy the demands of an individual, but also satisfies the needs of national economy. In today's ever-changing world, economic progress of a country strongly relies on technological advances as well as intellectual workforce in close coordination with these advances (Thurow, 1999). In order to achieve this, vocational education is considered as one of the means to supply this competent workforce for the needs the labour markets. It grants the efficient usage of both operational and operative resources and also enhances the capability of individuals to ensure the effectiveness and quality of production. It is also a focus of vocational education to cover in-service training of adults in order to achieve a consistent lifelong learning, as the occupational skills needed by industry changes in parallel with technological developments (Mulcahy, 2000).

By its nature, vocational education is a broad concept since its evolution highly depends on the innovations in both education theory and work systems. Today's vocational education thought is a result of a relationship between these two dimensions and dated back to the humanity formation. Alkan, Doğan and Sezgin (2001), summarize this development into various phases. Between the years 700-1000 A.D., families were handing over their occupation to their children for enabling continuity of skills, since the only fundamental social union in community was the family at that time. At the beginning of eleventh century, with the ending of feudalism, commercial relationships have increased between the states. This leads to a rise in the variety of jobs and gives importance to the specialization in occupation (Alkan, Doğan, & Sezgin, 2001). At this period of time, apprenticeship system has started as the first vocational education attempt for providing expert training to individuals. After completing primary education, students attended apprenticeship training with the guidance of master craftsmen. This type of vocational education system was supported by informal activities and individual differences (e.g. students' age or level of proficiency) were not considered. Furthermore, little importance was given to certification of acquired skills in this term (Benavot, 1983).

These unofficial training efforts, however, has weakened with the introduction of first industrial revolution (i.e. fabrication system) during the 19th century.

Fabrication system required more standardized job training processes as a result of modern occupational skill demanded by the newly established industrial firms. Hence, as a response to these needs, industrial associations and town councils started technical/vocational courses as formal apprenticeship programs in which part-time instruction was combined with workplace training. Mechanic institutes in England, trade and continuation schools in Germany and Switzerland and practical schools of commerce and industry in France are some examples of these early industrial school frameworks (Finch & Crunkilton, 1989).

After the Second World War, with the beginning of massive machine usage in production, high automation has started a big reform movement in traditional production process. It is also regarded as the second industrial revolution. As a result, life and working environment has become more specialized and complex and, accordingly, individuals have required more comprehensive and advanced vocational education. Therefore vocational schools have transformed into a central element in educational system. These schools have perceived occupation and education as a whole and aimed to respond to both the social and economical needs of community (Alkan, Doğan, & Sezgin, 2001). The main intention of vocational schools during this time was to train and integrate individuals from lower socio-economic status into the economy and to support equal educational opportunity for everyone.

Consequently, in today, vocational education functions as a tool to prepare individuals for their continuous careers - not for immediate entry-level jobs. (Bragg, 2001) emphasizes that modern vocational education perspective requires the integration of academic and technical concepts to activate lifelong learning principles, and as a result, to train successful employees. That is the reason that vocational education needs to support all standard skills essential to perform a job through a whole working life in addition to basic entry-level skills.

With this objective in mind, a typical vocational preparation starts with the acquisition of general skills and continues with job specific skills. Trainees progress vertically in the system such as technician, engineer and scientist instead of early specialization in a job such as electrician or computer technical service. Such a pathway allows the students to gain broader skills for the adaptation to

the ever-changing labour market requirements throughout their working life.

In addition, industry requires their employees to obtain the capability of adaptation to the changing structure in work environment. As a result of the globalization, these changes are much higher than ever in the market. Hence, in contrast to the traditional vocational education perspective that prepares the individuals on narrowly defined skills, today's vocational education focuses more on life-long learning principles in order to ease adaptation to changing conditions. This also results in the ability to analyze and solve problems by using the emerging information and technology, and the ability to work in teams by establishing communication (Bragg, 2001).

At this point, in order to catch the changing demands of market, vocational education should be strongly linked to the industry. Ziderman (1997), offers some strategies to achieve this school-industry connection. First of all, vocational school curricula need to be broader for supporting future trainability of employees. It should allow the employers to play an active role in curriculum development process. Furthermore, curricula need to be more flexible to update themselves based on the evolving labour market needs. Secondly, work place training opportunities should be enhanced, as they are crucial to provide the practice for trainee's occupational skills in a real life work environment. And finally, career counselling and guidance services must be provided to improve encouragement (Ziderman, 1997).

2.2. Education System in Turkey

One of the most important purposes of a national education system is to develop qualified citizens. This will result in a continuous improvement both in cultural and economical levels. Therefore a country can take its position in an international context. With this objective in mind, Turkish education system has already been shaped with the National Education Basic Law (No.1739) enacted in 1973. In this core law, the basic principles of Turkish National Education, school buildings and facilities, educational infrastructure, and responsibilities of the actors are all regulated as well as the general structure of the system (Gürbüz & Balcı, 1997).

Actually the roots of today's education system have been established after the

foundation of Turkish Republic (1923) with the enactment of the Law on Unification of Education in 1924. This significant law has brought all the schools in Turkey under the management of the central authority and rearranged them around a common purpose (Başaran, 1999). Since this new construction, The Turkish Education System is divided into two main sections as formal and non-formal education.

2.2.1. Formal Education

Formal Education covers Pre-school education, basic education, high school education and higher education:

Pre-School Education: Pre-school education is for the children who are younger than school age (4 to 6) and it is not compulsory. The aim of this education is to develop physical, psychological and affecting abilities of children in early ages and to prepare them for basic education. (Olkun, 1995)

Basic Education (Primary Schooling): Basic education is the compulsory education that students are supposed to start at the age 7 and study on general knowledge for 8 years. Until the academic year 1997-1998, schooling career was starting with five-year compulsory primary school, which would be enhanced with a three years secondary school optionally. This configuration has changed by Law no. 4306, on 18 August 1997, into a eight-year compulsory basic education for the children between ages seven and fifteen (MEB-MEGEP, 2006).

High School Education (Secondary Schooling): Students attend high schools optionally for four years after completing basic education. High school education can be divided into two main categories: One of them is General High Schools, which offer students general knowledge and aim to prepare students for further higher education. The other one is Vocational and Technical High Schools that provides specialized instruction on an occupation in order to train qualified work force. The latter category is discussed in detail in following sections, as it is the main topic of this study.

Higher Education: Higher education consists of universities and non-university institutions such as police academies, military academies and colleges. Each university includes faculties (four-year undergraduate programs), offering

bachelor's level programs, two-years vocational colleges offering pre-bachelor's level programs on a strictly vocational nature, and institutions offering graduate programs (i.e. master and doctoral degree programs). Students continue higher education mostly depending on their scores in nation-wide Student Selection Examination (ÖSS) which is held once a year and is administered by the Student Selection and Placement Centre (ÖSYM)(YÖK, 2005). On the other hand, vocational high schools graduates have the opportunity to continue a two-year vocational college within their discipline without participating in ÖSS. Furthermore, there are also open learning institutes which offer flexible educational programmes through e-learning (MEB-MEGEP, 2006).

2.2.2. Non-Formal Education

Non-Formal Education includes education, training, production, guidance, and implementation activities which are not provided within an official education program and/or do not end with an official certificate (ETF, 1999). As introduced in the National Education Basic Law (no. 1739), non-formal education activities have been arranged in an integral way to complement formal education for those who have never entered the formal education system (or are at a certain level of the system or have left the system at a certain level) (Akpınar, 2004).

All private and public organizations or institutions can provide non-formal education activities through short or long term courses depending on the local sector and community needs in order to train individuals on required skills or spare time habits. However, the organizations of these activities need to be approved by the Ministry of National Education (MoNE). Most of the non-formal education activities carried out through Public Training Centres, Apprenticeship Training Centres and Continuing Education Centres in accordance with the local district's requirements (Gürbüz & Balcı, 1997). One of these organizations, the Apprenticeship Training Centres, also offers vocational education and training to youth and is discussed in detail in following sections. **Figure 2** depict the details of how these sub-systems are connected to each other and how the whole Turkish educational system can be shown schematically.

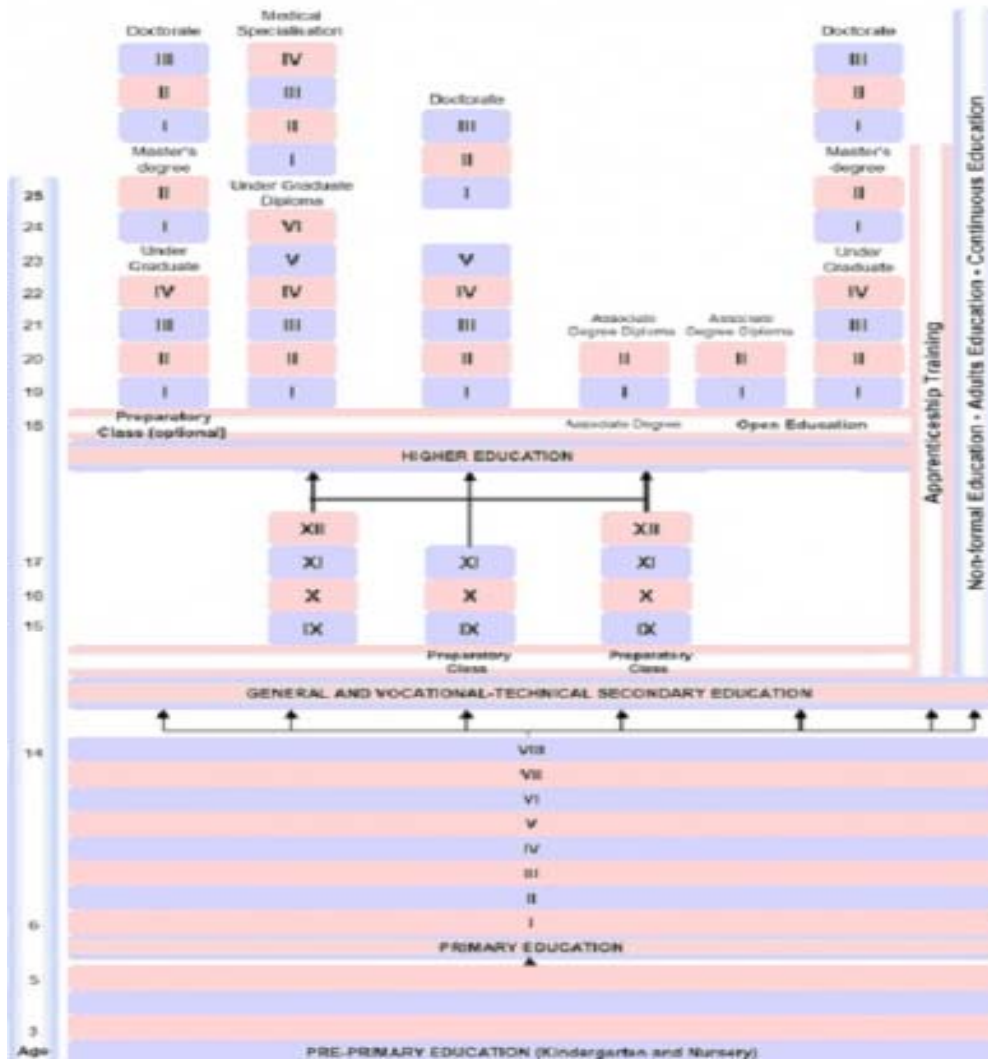

Figure 2. Schematic presentation of the Turkish educational system (Source:(MEB, 2007b))

2.3. Development of Vocational-Technical Education in Turkey

2.3.1. Historical Background

Vocational education in Turkey has inherent roots dating back to the Professional Guilds (i.e. Ahi Birlikleri) which emerge as tradesmen association and survived from the 12th to the 16th century (Akpınar, 2004). Unluhisarcıklı (2005), states that the basic aim of the Ahi system was to provide economic and occupational help to everybody for social equality. This association was a non-governmental apprenticeship system, which students begin at the age of ten in a workshop to

master vocational and social skills of an occupation (Unluhisarcikli, 2005).

Besides this early attempt, the initial foundation of the current vocational education schools dates back to the 19th century. During these years, the schools were mostly funded by the local governors and operated without an explicit consent from the central administration (Akpınar, 2004).

After the Turkish Republic is founded in 1923, the educational system has changed very rapidly (Akkoyunlu, 2002). It was planned action for the modernization and the spread of educational institutions nation-wide. A number of important steps were taken one of which was to collect the schools (including vocational schools) under the management of the central authority (Ministry of Education). At the very beginning of this term, the basic aim of vocational and technical education was to train well-qualified work force for the needs of country defence and industry, and accordingly to introduce new technology to the local community (Sezgin, 1987).

Nine vocational schools for boys, two for girls and five commerce schools were opened between the years 1923 and 1927 with a total number of 1060 students (Simsek & Yildirim, 2000). At the beginning, local authorities were responsible for establishment of these schools in addition to administrative and instructional functionalities (Başaran, 1999). MoNE was only responsible for their approval and investigations (Olkun, 1995). Therefore, there was no agreement among the schools in terms of the proficiency of instruction, administration, logistics and entry regulations. The Vocational Schools Law (No.1052) was enacted in 1927 with the intention of handling this diversity between vocational schools. The focus of this law was to organize the vocational schools under the framework of MoNE for a common purpose, resulting in a response to the requirements of whole country (Alkan, Doğan, & Sezgin, 2001).

In fact, the milestones of today's vocational and technical education were constructed with the law legislated 1933 (No.2287), in which the central structure of MoNE was re-organized and a general directorate were established specific to the vocational and technical education. As the expenses of vocational schools are also funded by the Turkish government in 1930s, the number of the schools had increased very rapidly (Başaran, 1999). More importantly, in this period the

vocational schools were arranged into ten vocational areas and their curricula were updated based on the new vocational skills. These areas were: wood working, lathe, modelling, electricity, furnishing, painting, building, and textile (Olkun, 1995). In addition to vocational schools, in 1940s vocational courses for skilled labour force and in 1960s 1-2 year practical trade schools for primary school graduates were offered. It is also in the 1960s that the length of vocational high school was 5-to-6 years after compulsory 5-year primary education. In the 1970s, 4-year technical high schools were also introduced in the system.

Besides the construction and organization attempts of vocational schools, teacher-training activities were also handled in order to meet the increasing demand for qualified trainers in vocational education. Teachers were sent to foreign countries for occupational training as well as foreign teachers were brought to the country between the years 1927 and 1938. Furthermore, in the 1934-1935 schooling year, the first Vocational Teacher School for girls, in the 1937-1938 schooling year the first Vocational Teacher School for boys and in 1955 the first Commerce Vocational Teacher School were established (Alkan, Doğan, & Sezgin, 2001).

After the reorganization of Turkish National Education System with the Basic Law on National Education (no. 1739), apprenticeship training is also adapted into the education system with a special Law of Apprenticeship, Journeymanship and Mastership (no. 2089) in 1977. This law systematically arranges the apprenticeship, journeyman and masters training activities: entrance prerequisites of the system, education period, responsibilities of apprentice and employer, scope of the apprenticeship agreement and other factors related to the training. However there were still obstacles in the system such as insufficient supervision, lack of organization and limited experiences of teachers and employers so that 98 percent of the apprentices were working informally without a contract (Unluhisarcikli, 2005). (Sezgin, 1987) also criticizes the limitation of industry participation to the process of vocational and technical education in this period of time. Consequently, Law of Apprenticeship and Vocational Training (no.3308) is enacted in 1986 in order to handle these obstacles. With this act, initial vocational education has been reorganized into an integral system consisting of formal, non-formal vocational education and apprenticeship training. We can state the basic aims of this law as

follows:

1. To provide regular apprenticeship training for students who left formal education or couldn't attend after compulsory education because of some reasons
2. To provide an opportunity for vocational school students to develop their skills in a real life work environment
3. To arrange vocational courses in order to train the adults who don't have vocational skills for employment
4. To supply extra financial resources for developing and expanding vocational and technical education activities.
5. To enhance research and development in vocational and technical education
6. To enable the involvement of the industry partners to the planning, development, implementation and evaluation stages of the vocational education (Sezgin, 1987).

Law of Apprenticeship and Vocational Training have resulted in remarkable revolutions in the vocational education system. It launched the coordination between state, students and industry. By enabling the students in vocational schools to practice their skills in a real life work environment, the training opportunities has extended into a more practice-oriented experience (Tunali, 2005). Vocational Education Councils have also been established in accordance with the law, at national and local levels so as to plan, develop and evaluate the vocational education activities and to inform the MoNE on this coordination(MEB, 1986). Moreover, a giant step forward was taken in the decentralization of the system with the Tradesmen and Craftsmen Law (1991). This law has delegated the authority and responsibility of planning, implementing, evaluating and monitoring of the work place training for apprentices to The Turkish Confederation of Tradesmen and Craftsmen (TESK)(ETF, 1999).

Law of Apprenticeship and Vocational Training is reformed by the establishment of Law no. 4702 pronounced in 2001, with the intention of rearranging and

strengthening the vocational and technical education system. One of the significant innovations in the new system is Vocational and Technical Education Regions established throughout the country. They are defined as “education regions incorporating two-year vocational colleges to connect to one or more vocational and technical high schools in educational program integrity and continuity” (MEB, 2001). With this new framework vocational high school graduates have an opportunity to continue two years vocational colleges for associate’s degree on their specialized area without taking Student Selection Examination (ÖSS) in their education region (Akpınar & Ercan, 2002). 10% of all students graduating from these colleges can continue to four years universities for an undergraduate study (MEB-MEGEP, 2003e). Other improvements in the system to promote vocational education opportunities are summarized as follows:

- Construction of vocational and technical education centres in which students can acquire certificates and diplomas via formal and non-formal occasions.
- Supporting horizontal/vertical transfers opportunities for students within the framework of education system: formal, non-formal and apprenticeship educational institutions.
- Assemble of educational units for 10 or more students by the labour force, in which vocational school students can practice occupational skills.
- Assessment of employee’s occupational competencies and offering required in-service training for them (MEB, 2006a).

According to latest structure represented in **Figure 3**, if the graduates of vocational high schools wish to attend a higher education institution for bachelor’s degree within their discipline, they have to success in Student Selection Examination (ÖSS). In this case, they will be awarded with additional points based on their high school grade. Furthermore, they have an opportunity to upright move to the connected undergraduate programs depending on their scores of Vertical Transition Exam (DGS) after taking an associate’s degree. On the other hand, if the graduates of vocational high schools want to attend an area disconnected to their vocational branch, it is almost impossible because of decrease in high school

grade point averages, which are added to the ÖSS score compared with general high school graduates. In addition to this complication in continuing higher education, the number of these institutions and areas are very limited for vocational high school students.

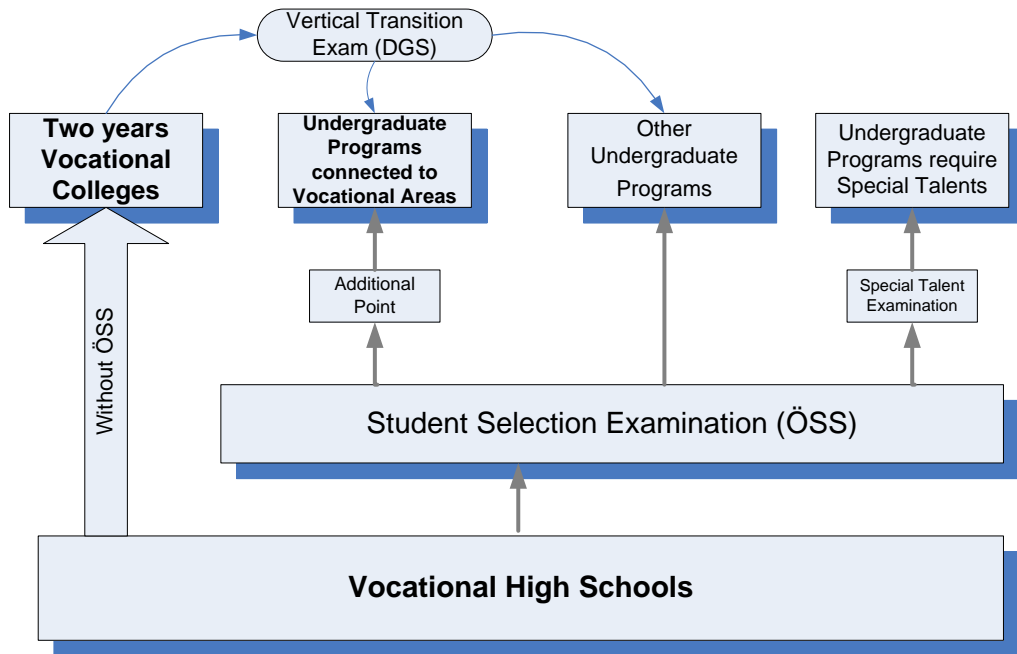

Figure 3. Transition to Higher education

(Source: (Eşme, 2007))

Besides the aforementioned laws, Turkish National Education Council (SURA) and Development Plans are imperative building blocks in the construction of national vocational education system. The council was established firstly in 1926 and meets every three years with the intention of promoting quality in the Turkish national education system. The decisions of 7., 8., 9., 10. and 16. Turkish National Education Council has almost shaped today's vocational education arrangement and proceedings (Alkan, Doğan, & Sezgin, 2001). The 16. Council, enacted in 1999, analyzed the national vocational education system in detail and recommended the reconstruction of system, vocational schools, workplaces, teacher and administrator training, and financial issues (MEB, 1999). Furthermore in the last National Education Council in 2006, expanding vocational

education opportunities are discussed in a scientific and effective way to support the students financially and socially, and to rearrange the areas for vocational schools. As a result, horizontal and vertical transfer lines through steps of the system were recommended in order to adapt the National Education System into the European context (MEB, 2006b).

National Vocational Education System constitution, roadmaps and strategies were analyzed in the development plans as well. In the last 5-year plan for 2007-2013, it is stated that updating the vocational education system based on the changing needs of labour is needed to be done in collaboration with social partners. During the next five years, vocational education system will be rearranged into a flexible framework in which the high schools and higher education institutions constitute the program integrity (TBMM, 2006). The aim of this effort is to train the vocational students as the individuals, who work with peers in collaboration, think analytically to handle difficulties, and take responsibility to master required occupational skills.

2.3.2. The Recent Organization of Formal Initial Level Vocational Education System

MoNE is responsible for training skilled workforce on several branches of business at technician level in Turkey. To achieve this, vocational education system is carried out via four General Directorates (DGs) beneath the framework MoNE. These DGs were arranged through the structural changes between 1941 and 1980, in order to manage the different schools and training centres of the system based on their target sector namely:

- DG of Technical Education for Boys;
- DG of Technical Education for Girls;
- DG of Commerce and Tourism Education;
- DG of Apprenticeship and Non-formal Training.

The hierarchical positions of these four Vocational Directorates are shown schematically as a representation of MoNE framework in **Figure 4** (MEB-MEGEP, 2006).

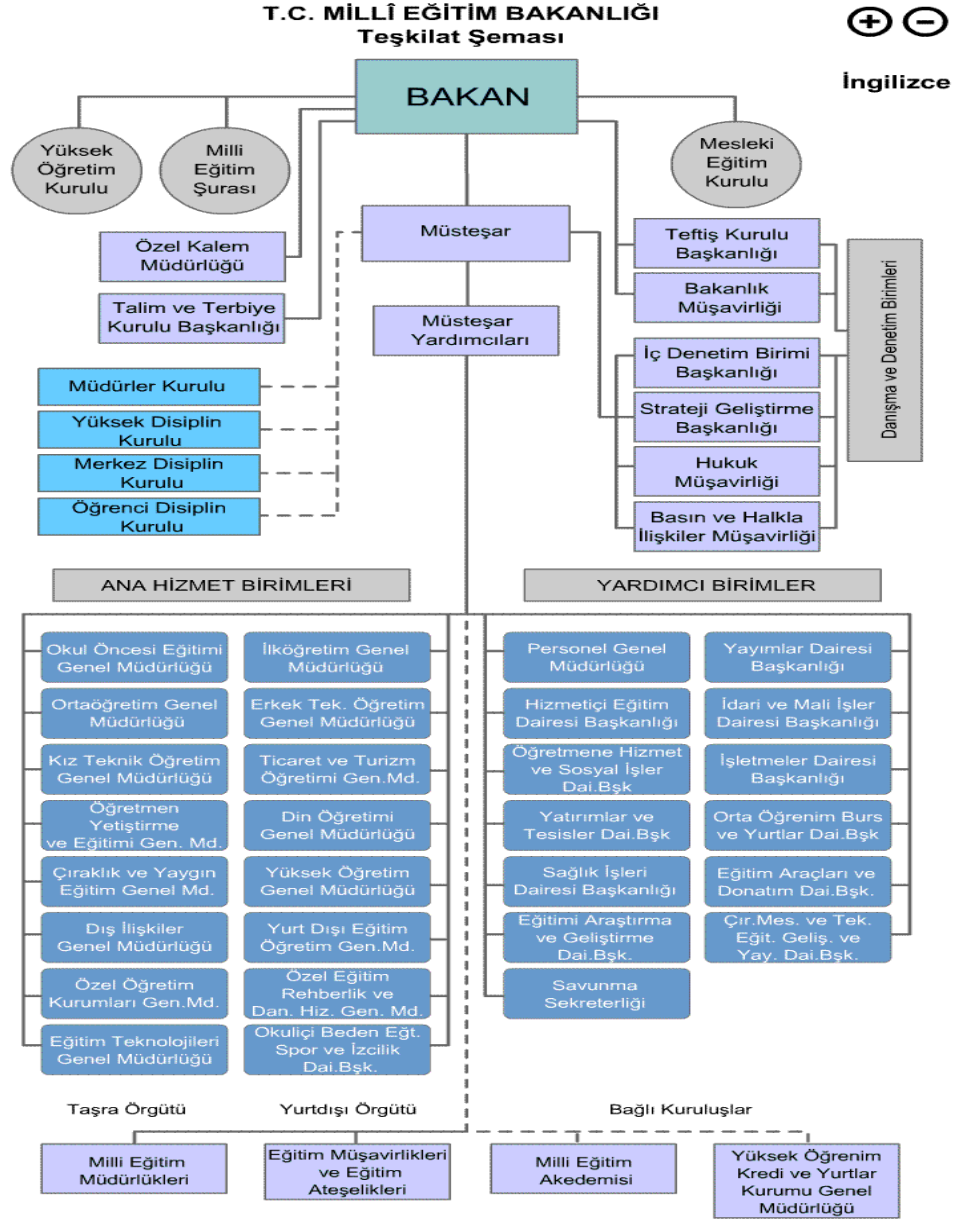

Figure 4. MoNE framework

(Source:(MEB, 2007b))

Within this construction, initial formal vocational and technical education is offered by vocational high schools and technical high schools. Students can attend these formal vocational education institutions after successfully completing 8 years compulsory basic education. The diagram of vocational pathways is illustrated in

Figure 5.

courses including general academic subjects such as literature, mathematics, foreign languages etc. Therefore, students have a chance to horizontally transfer between two types of high school institutions and programs at the end of this year, excluding the schools that admit students with elective examinations.

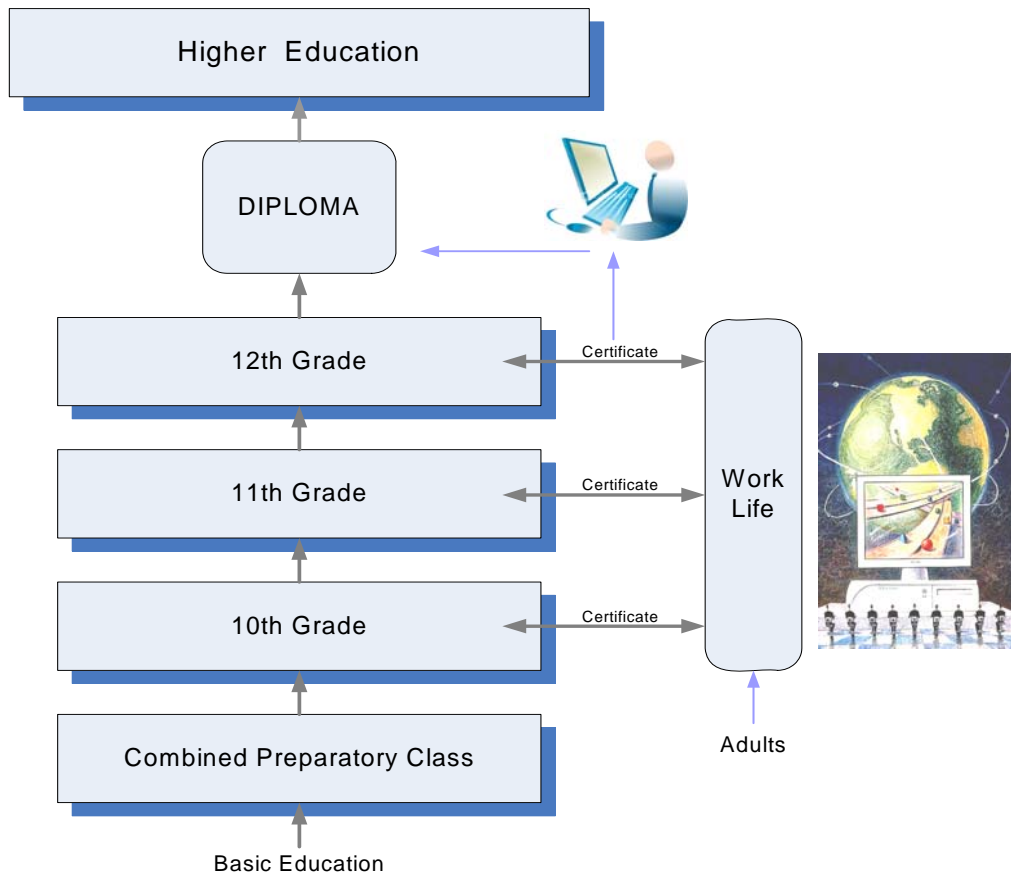

Figure 6. Newly Organizational Structures of Vocational High Schools

Starting from the 10th grade, vocational high school students decide on their occupational area in the light of their teachers' and parents' recommendations. These job-related areas are specified based on the local community and labour market needs and facilities of school. After mastering must-courses of the selected occupation at the 10th grade, students select a branch of the job and continue with special courses of this branch at the 11th grade. Finally, the last grade (i.e.12th) heavily focuses on work-place training in which students get the opportunity to practice their skills in a real life setting. This new structure is illustrated in

Figure 6.

Although the organizational structure is the same for all vocational high schools arranged by the DGs of MoNE, their names differ up to the related sector. Some of these names are introduced below (Akpınar & Ercan, 2002):

- Industrial Vocational High Schools
- Girls Vocational High Schools
- Commerce Vocational High Schools
- Tourism Vocational High Schools
- Religious High Schools
- Health Vocational High Schools
- Agricultural Vocational High Schools

Moreover, vocational high schools are enhanced with three different types: Anatolian vocational high schools, Technical high schools, Anatolian Technical high schools.

Anatolian Vocational High Schools

Anatolian Vocational High Schools are similar to vocational high schools except an addition that they provide students extra hours of foreign language classes with the intention of training well qualified labour force, who can follow the global sector improvements in their occupational area. One more difference is also in the entrance that students attend these schools up to their scores in centralized examination after basic education.

Technical High Schools

Technical High Schools also provide students 4-year education on occupational skills and general academic knowledge like vocational high schools. On the other hand, the curricula are heavily focused on general cultural courses such as literature, mathematics and physics compared to vocational high schools. In addition, Technical High Schools accept students according to their success grade

point at 9th grade. As a result, the aim of technical high schools is to prepare students for higher education institutions besides working life.

Anatolian Technical High Schools

Similar to Anatolian Vocational High Schools, Anatolian Technical High Schools also provide students extra hours of foreign language classes. However, they follow curricula similar to Technical High Schools that distinguish them from the vocational high schools. Additionally, the entrance to these schools is also performed based on the scores of students in centralized examination after basic education.

All types of Vocational High schools with the schooling year 2005-2006 have begun to implement new modular curricula, which is a result of a big project named SVET (Strengthening the Vocational Education and Training System in Turkey). SVET is a five-year project resulting from an agreement signed between the European Commission and the Government of Turkey in 30 September 2002 (MEB-MEGEP, 2006). The overall objective of this project is to assist the Turkish Government, through the Ministry of National Education, in the process of modernization and adaptation of the VET system to the socio-economic needs of the country and to the principles of life-long learning (MEB-MEGEP, 2003e). This attempt results in the development of an up-to-date and flexible vocational education system that is responsive to the sector needs, well adapted within the educational system and accredited within the Europe.

According to the updated curricula, vocational education is offered on 42 occupational area and 197 departments at vocational and technical high schools. The weekly time set specified in curricula framework vary between 35 and 45 hours up to the vocational school types mentioned above (MEB-MEGEP, 2007b).

2.4. Rationale of Change for the Formal Initial Level Vocational education system

Vocational education system is examined entirely in the 16th Turkish National Education Council (1999) under the headline “Weighed Reorganization of

Vocational and Technical Education within the Integrity of the Secondary Educational System”. The important topics range from restructuring vocational training as a secondary education to the financing of vocational schools. Some of these declarations of council are listed as follows:

- Reconstructing VET system in which the horizontal and vertical transition opportunities between programs are supported
- Organizing training programs based on modular approach in order to provide forming certification system
- Collaborating with social partners and local governments
- Enhancing types of vocational high school programs by enabling common usage of physical opportunities(Şimşek & Gök, 2005)

High School Type	Number of Students	%	Number of Schools	%	Number of Teachers	%
General	2.141.218	63	3690	47	58.388	31
Vocational-Technical	1.244.499	37	4244	53	84.276	69
Total	3.386.717	100	7934	100	187.665	100

Table 1. *Number of Students, Schools and Teachers in High Schools in 2007*
(Source:(MEB, 2007b))

Basic vocational education is commonly implemented at secondary education step (vocational high schools) in Turkey as an initial formal education attempt. Before introducing the leading problematic issues of basic vocational education system, it is beneficial to see the whole picture of the secondary level education system.

According to the statistics of 2007 listed in **Table 1**, the number vocational high school is 4244, while the number of students in these schools is 1.244.499. There are 84.276 teachers employed, so the number of students per teacher is 15 in vocational high schools and 37 in general high schools (MEB, 2007a). Moreover if the expense of one student for per year education is considered, this value is 2.208 TL in vocational high schools and 1.259 TL in general high schools (Eşme, 2007). On the other hand, despite all these advantages, the proportion of students in vocational high schools is 37% in comparison with the proportion of students in general high schools 63%.

The European Training Foundation (ETF), an agency of European Union working in the field of vocational education and training, has produced a report on the system of vocational education in Turkey in 1999 with the intention of future improvement. According to this report, the dated vocational training system was not responding the needs and interests of youngsters and adults. Also, vocational training was failing to meet the rapidly changing needs of industry and technological advances of today's world. (ETF, 1999).

In the report, it is highly stressed that initial level vocational education was not able to provide a high-quality education to meet the demands of labour market and community. This result in a significant drawback for vocational high school graduates when they face the possibility of the unemployment and the failure in attending a higher education program. Accordingly, this leads to an increase in students' preference of general high schools. In the report of World Bank, it is also stated that according to the results of the 1997 Formal and Adult Education Survey, only 45% of the vocational high school graduates find jobs directly related to their training and 14% of them are reported that their jobs are at least partially related to their training (Ogawa & Tansel, 2005). Therefore, in the following subsections, we introduce the leading problematic issues of the previous initial

level vocational education one by one.

2.4.1. Centralized education system

The first and the most important setback of the previous system was its centralized nature. Approval of changes in curriculum was a long and unpromising process for the administrators and teachers. It was mostly impossible to adapt the curriculum in accordance with the rapidly changing needs of global and local industry. This unfeasibility of adaptation is mainly caused by application of nationwide standardized curricula in vocational high schools, although they were insufficient in responding needs of local labour market, community and students as well. This situation is fostered with the nationwide needs-assessment processes performed by the MoNE while preparing vocational curricula (i.e. that's why the nationwide standardized curricula did not respond the local level needs).

Moreover, in a short period of time, standardized nationwide curricula became obsolete because of the changing environment in world of work parallel to the fast technological innovations. Therefore, it is clearly seen that, in order to maintain update functionality in the curriculum, there should be strong linkage between vocational schools and industry. However, the local industry participation to the decision making process was insufficient in most parts of the vocational schools, in order that students were trained with outdated curricula in the old vocational education system (Yildirim & Simsek, 2001).

2.4.2. Ineffective Vocational Curricula

The old Vocational High Schools' curricula were constructed based on the approach called "narrow specialization fields". This approach caused one of the obstacles in vocational education system that program graduates were having difficulties in the adaptation of rapidly changing structure of work environment due to the lack of a broad basic foundation of skills and knowledge.

The European Training Foundation has reported that in our system, transference of concepts, abilities and skills from general academic courses to the world of work is unsatisfactory in contrast to what industry wants. It was the fact that the implemented curricula were unaware of the realities of the world of work (ETF,

1999). A functional link was missing between vocational education system and employment. Hence vocational high school graduates do not have the demanded qualifications of labour markets. On the other hand, there is lack of qualified blue-colour workforce in the enterprises (Şimşek & Gök, 2005). In the report of World Bank, it is also stated that according to the results of the 1997 Formal and Adult Education Survey, 36% of secondary vocational graduates has indicated that their training does not contribute to job performance and 16% of them has said that their training only partially improves job performance (Ogawa & Tansel, 2005).

Today's vocational education perspective should focus on generic skill acquisition such as ability to analyze and solve problems and use new and updated information and technology in accordance with life-long learning principles (Bragg, 2001). Industry requires graduates of vocational schools not only to master on narrowly defined skills, but also to learn the adaptability to the work environment in line with changing skill needs of their occupation. This is only possible by gaining comprehension skills in addition to the ones required by the job. Furthermore, in ETF report, it is also stated that graduates of vocational schools were lacking these skills such as good communication, team spirit, interaction and corporation with peers.

2.4.3. Inflexibility of System

Rigid structure was also one of the deficiencies in the old initial vocational education system. The curricula were not constructed on *competencies*. Occupational standards and a testing system based on occupational standards did not exist. Thus, there were problems in the assessment of students. The assessment criterion was just to successfully complete all the courses during one year of schooling (Güney & Oğuz, 2002).

Students were having a diploma only if they finish three or four years of vocational high school period. Vocational education system was not offering certification to students who leave the system before time, based on their gained skills. Therefore the system was not meeting the international standards.

Moreover, because of the rigid structure of the system, students did not have an opportunity to transfer among occupational areas within the vocational high

schools or between vocational high schools and general high schools. They also did not have a chance to select among courses up to their preferences or abilities. The number of elective courses was very limited. Hence, there was not a flexible structure of integration even inside the formal education system or among the formal and non-formal education systems.

2.4.4. Incompatible Educational Methodology

Traditional teacher-dominated pedagogies are unsuited to today's vocational education perspective. More student-centred, project-based, active and constructivist approaches are needed (Grubb, Badway, Bell, Bragg, & Russman, 1997). ETF reported that, in our vocational education system, the applied teaching methods were incompatible with students' learning styles, so a different approach, in which the educational technology is utilized properly, was required (ETF, 1999). Students' individual differences, needs and preferences should be considered in the curriculum implementation process and they should be more active in the learning process.

Furthermore, work-based learning is an important opportunity of vocational education which offers students to make connection between theory and practice and helps them to easily adapt to the work environment (Bragg, 2001). Therefore these activities should be enhanced for supporting experiential learning and supporting students to practice their skills with peers, collaboratively in-group work.

2.4.5. Insufficient Vocational Counselling

Insufficient vocational counselling offered at basic education level was another complication in the initial vocational education system. Students were selecting their occupation when they enrol to vocational high schools and they had no chance to change it afterwards. Hence they were doing this selection according to limited career guidance at basic education level before they experience vocational high school environment and accurately recognizing job specific characteristics (Akpınar & Ercan, 2002). They need to be aware of their capabilities and desires before coming to secondary level education. Thus, more advanced counselling

opportunities should be offered at basic education level (Güney & Oğuz, 2002).

2.4.6. Limited Transition to Undergraduate Programs

According to the newly adapted structure of transition between vocational high schools and higher education institutions explained in previous subsection, vocational high school graduates have an opportunity to continue two years vocational colleges for associate's degree on their occupational area without taking Student Selection Examination (ÖSS). On the other hand, if the graduates of vocational high schools wish to attend undergraduate programs for a bachelor degree within their discipline, they have to success in Student Selection Examination (ÖSS). In this case, they can also benefit from additional points based on their high school grade. In addition two years vocational college graduates also have a chance to continue connected undergraduate programs after two years vocational college, up to the their score in Vertical Transition Exam (DGS) and their college grades.

According to the statistics of 2005, the transition percentage to higher education institutions is 18% for general high school graduates and 27% for vocational high school graduates including both associate's degree and bachelor's degree programs. Nevertheless, the number and the variety of undergraduate higher education institutions connected to vocational programs are limited. According to the statistics of 2005, the total capacity of undergraduate programs available for vocational high school and vocational college graduates is 33.000. Moreover Vocational and Technical Teacher Training Faculties are the only bachelor's degree choice for vocational school graduates and these faculties are far from responding to the needs of either industry or individuals (Eşme, 2007).

2.4.7. Incompetent Vocational Teachers

The shortage of connection among vocational teachers and industry is also a deficiency of system. They do not have sufficient experience in their expertise area. Also in-service training activities offered by MoNE are not satisfactory. Another important deficiency concerning vocational teachers is their geographical distribution countrywide. There is an aggregation of teachers in big cities.

2.5. Vocational and Technical Education Curriculum

The name "Curriculum" comes from the Latin word "Curro", it means "Quick walk". This implies that a curriculum describes a quick walk through an educational process and as such it is an educational planning document. The curriculum term was used firstly in the nineteenth century and evolved during the twentieth century up to the changes in role of the school in society, conceptions of learner, and the nature of the knowledge. Different philosophical foundations such as traditional and progressive conceptions provide different curriculum definitions because of their viewpoint of the knowledge. Furthermore, the knowledge is dynamic and changing according to the progress in the world. Therefore, evolution of curriculum definition is a requirement to give energy to improvement in education.

“The body of subjects or subject matters set out by teachers for students to cover” (Tanner & Tanner, 1975). After this first broad definition of term curriculum, he described curriculum as “reconstruction of knowledge and experience, systematically developed under the auspices of the school (or university), to enable the learner to increase his or her control of knowledge and experience” (p.38). This definition states that curriculum is a harmony, which is more concerned with students’ ability and the knowledge in order to control it than students’ personal-social problems.

Following definitions of curriculum has taken into account the culture of the society besides traditional knowledge. According to these definitions, curriculum is a medium to transmit the values, attitudes of a society to the next generation. One of them is definition of Smith, Stanley and Shores: “a sequence of potential experiences is set up in the school for the purpose of disciplining children and youth in group ways of thinking and acting” (Tanner & Tanner, 1975). When the experience is considered as conception of curriculum, the needs of community should be taken into consideration in order to improve the common life conditions. In this conception, curriculum is defined based on the progressive philosophical foundations; thus, the idea behind curriculum is giving emphasis to students instead of subject matter. Among the child-centered theorist, Dewey has stressed that learning activities should be centred around the child’s needs and

interests so the curriculum should be flexible. Therefore, at this point, the aim of the curriculum is to develop child's maturity and self-exposure.

The other important concept in curriculum definition is guided learning experiences. According to this conception, Foshay has defined curriculum as "all the experiences a learner has under the guidance of the school" (Tanner & Tanner, 1975). This definition is very critical because it considers not only the formal course outcomes but also the whole knowledge that students learn in a school environment therefore this definition is the first advancement in traditional conception. However, this definition is too broad and includes both intended and unintended experiences. In this manner, Tyler's definition prevailed over this problem with his curriculum definition as "all of the learning of students which is planned by and directed by the school to attain its educational goals" (Tanner & Tanner, 1975). With this definition, he emphasize that the curriculum should address the educational objectives, not the unintended ones.

Taba's viewpoint is based on the curriculum as an instructional plan conception. Therefore he defined curriculum as " a curriculum plan for learning" (Tanner & Tanner, 1975). Also Beauchamp supported Taba's idea and defined curriculum as a written document. Although these definitions are simple and clear but results the problem of dualism, no distinction between curriculum and instruction, because these definitions are same with the definition of a lesson plan or unit plan. Furthermore in these definitions there is no difference between a curriculum and a syllabus.

According to the curriculum as a technological system of production conception, the behaviorists emphasize activity analysis in order to define specific activities that will be used stating curriculum objectives. In this manner Bobbitt defined curriculum as "that series of things which children and youth must do and experience" and Charters defined as " in its simplest forms it involves the analysis of definite operations, to which the term job analysis is applied, as in the analysis of the operations involved in the running a machine" (Tanner & Tanner, 1975). Both of them used analyses of the production models of business and industry in terms of system approach.

And the last conception Taba (1962), explained curriculum as ends. Regarding this conception Baker defined curriculum as “all planned learning outcomes for which the school is responsible” (Tanner & Tanner, 1975). In this concept curriculum is mechanic process and can be formulated according to the objectives. Gagne also supported this idea that learning is mechanical and linear process. And finally in terms of these conceptions Tanners restated their own definition as “all learning, which is planned or guided by the school, whether it is carried out in groups, or individually, inside or outside the school” (Tanner & Tanner, 1975). Their definition considers schools as learning environment and emphasize that systematic reconstruction of knowledge and experience is only the responsibility of schools no other social intuitions. Furthermore because of the dynamism of knowledge, education has no end. Therefore schools are mediums that control these dynamic learning experiences.

Saylor, Alexander and Lewis (1981), explained different definitions of curriculum based on the different conceptions. They defined curriculum as “a plan for providing sets of learning opportunities for persons to be educated”. In this manner theorists consider subject-centred or competency-based curriculum with the term ‘learning opportunities’. Also Johnson proposed that curriculum should deal with intended learning outcomes achieved through instruction; resulting from this concept a competency-based rationale was prepared. Moreover they consider formal school curriculum or open-curriculum as learning environment and a plan might be in teacher’s mind as intention and it depends on teacher’s creativity.

They also explained different conceptions of curriculum definition. They regarded subject matter as dominant concept because most of the teachers and students perceive curriculum as the sets of subjects. According to this concept planning a curriculum consists of expert judgments, criteria to select the subject and implementation methods. However this concept is not applicable today because there are lots of ingredients that constitute curriculum.

Moreover experiences are the other important concept of curriculum definition, which guided by teacher. Curriculum categorized based on the experiences: formal curriculum, perceived curriculum, observed curriculum and experiential curriculum. This categorization is a result of difference between planned,

enacted and experienced curriculum. As a result this concept mainly emphasizes relation of planning ends and means (Saylor, Alexander, & Lewis, 1981).

Finally Ornstein and Hunkins (1998), were declared different curriculum definitions. The first of them is “curriculum is a plan for action or written document that includes strategies for achieving desired goals and ends (Ornstein & Hunkins, 1998). Tanner and Tanner (1975) and Saylor, Alexander, and Lewis (1981), also mentioned analogous definitions. Furthermore behavioural theorists Tyler and Taba supported this definition. All of them perceive curriculum as a linear process and follow step-by-step strategies to work it (Tanner & Tanner, 1975).

The second curriculum definition is “all the experiences children have under the guidance of teachers” (Ornstein & Hunkins, 1998). He states that this definition concern a school environment and consider all the experiences that student learn, within the curriculum both the intended and unintended ones.

According to Ornstein and Hunkins (1998), the other viewpoint to the curriculum is the system approach. Some theorists perceive curriculum as a system, which consists of people and processes even linear or nonlinear. Furthermore the curriculum can be analyzed as field of study, which has its own foundation, domains, theories, specialists and knowledge. And according to the last concept curriculum can be considered in terms of subject matter or content (Ornstein & Hunkins, 1998).

The definition of term curriculum evolved based on different foundations. Some of these definitions were summarized from the viewpoints of the theorists Tanner and Tanner; Saylor, Alexander and Lewis, and Ornstein and Hunkins. Consequently it can be stated that each theorist has his own definition because each theorist has a different position about the world and knowledge. Therefore these definitions picture theorists’ perspective on curriculum work. Furthermore this evaluation in curriculum definition is a necessity because of dynamic construct of knowledge itself. Different theorists consider different ingredients. Although every subject, related to learning, is also related to curriculum but taking every term into account broader the field of curriculum. Hence in the following part common ingredients

of curriculum will be specified so the boundaries of field would be clearer.

Actually after stating several definitions of curriculum, the important point that should be focused in vocational and technical curriculum is its evident result oriented conformation. The differentiated feature of the vocational and technical curriculum is it should be formulated heavily considering the product occupational skills as well as other educational processes. However if the goals of the education taken into consideration as illustrated in **Figure 7**, the goal of general subjects “education for life” and the goal of vocational subjects “education for earning a living” are mutually inclusive (Finch & Crunkilton, 1989).

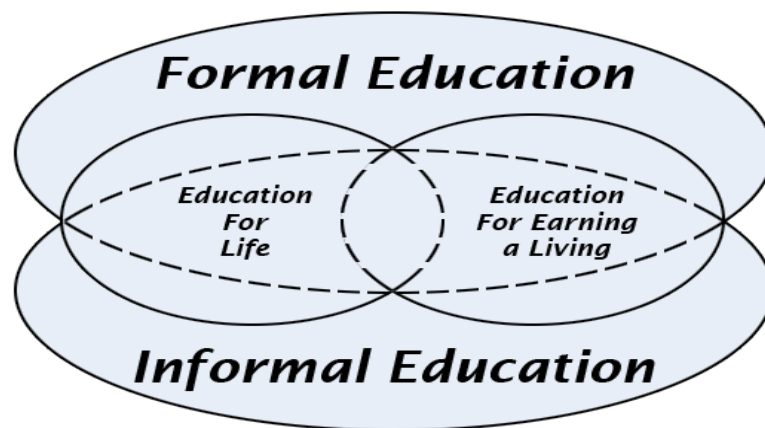

Figure 7. Goals of Education

(Source: (Finch & Crunkilton, 1999))

In the case of our country general high school education, preparation for life, serves as a basis of training for earning a living through higher education institutions or non-formal opportunities. Similarly, vocational high schools provide training on an occupation for early earning a living and also their curricula covers general subjects in order to adapt individuals to real life conditions. These two goals can be enacted in formal or non-formal educational opportunities as represented in the figure. Therefore in this jointly conjecture of two types of education, the above general definitions of curriculum also effective for vocational and technical education curriculum. Even though vocational and technical

education is a part of educational system, for the adequately development of a vocational and technical curriculum following characteristics should be considered.

2.5.1. Characteristics of VET curriculum

Vocational education is a sub-system of whole education system. However its function, structure and implementation processes differ from rest of the education milieu. Due to the vital role of vocational education in supplying qualified workforce to the industry and improvement in national economy, its distinguishing features should be examined in order to utilize benefits. The following features are identified in this scope:

Skill Acquisition

Vocational and technical curriculum focuses skill, attitudes and values related to a specific occupation besides theoretical knowledge for providing graduates easily employability. In addition to job specific standard skills, vocational and technical education should provide more generic skills to individuals in order to enhance adaptability to the rapidly changing work environment parallel to the innovations in technology. These skills should be determined based on occupational analysis(Yıldırım, Altın, & Yalçın, 2005).

Product Achievement

In the world of work, the graduated student achievement is evaluated heavily based on gained product skills instead of educational processes. Hence in vocational and technical curriculum development progress, the educational activities and applications should be arranged considering the results of them on vocational student.

Success Standards

As the vocational and technical education focus on occupational skills acquisition, the assessment of the vocational students should be performed by their hands-on performances in schools. In order to supply common skill acquisition to all graduates for a specific occupation, standards should be determined in consistent with the labour market criteria and expectations in the occupation (Finch &

Crunkilton, 1989). Thus, vocational and technical curriculum should be constructed based upon these standards for providing universal application between vocational teachers. Furthermore, the success standards are also very important for supporting a national qualification framework, which improve students' achievement and provide them opportunities to perform their occupation in the world context.

School-Industry Cooperation

Vocational and technical education should be responsive both to the local and national labour market and community needs in addition to the students' individual needs. And these needs are evolving up to the changing concept of the knowledge. Rapid technological innovations cause variations in occupations and occupational skill requirements of industry as well. Furthermore the expectations of community from vocational school graduates are also shifting in time. Therefore, in the development of vocational and technical curriculum process, schools and industry should work together closely. First of all, they should analyze the needs clearly and then they should arrange the educational activities according to these specified needs. And this cooperation should also continue during the implementation of curriculum for detecting the gaps and performing required updates immediately. Well-built school-industry cooperation results in qualified vocational curriculum and success of vocational graduates.

Flexible Structure

In order to execute required updates in vocational curriculum, it should be constructed as a flexible framework. It should be constituted of small components instead of a whole formation. In this way, adding or removing learning activities to the curriculum is easily applicable based on the changing needs of industry and community. Moreover the other important inevitability for flexible structure in vocational curriculum is it supports decentralization of the vocational and technical education system. It is easy to perform required modifications within the framework curriculum up to the local skill requirements of labour market.

Infrastructure Requirements

Vocational and technical education requires complex infrastructural physical

environment requirements such as equipments, materials, laboratories etc. because of providing personal discovery to trainees by performing practical activities (Yıldırım, Altın, & Yalçın, 2005). Thus while developing and implementing vocational and technical curriculum this speciality should be taken into consideration and curriculum should be designed in a way that teach the content with hands-on , practical activities. The current infrastructure of the vocational schools and needed new materials and their accessibility conditions should be evaluated up to the financial resources (Finch & Crunkilton, 1989).

Group Learning

Vocational school students learn concepts best through experiences and experiments. Likewise effective communication and interaction is another important generic skill that is demanded by the industry. Thus learning activities in vocational and technical curriculum should be arranged in groups in order to increase interaction between students by the way providing team working, sharing and mutual support (Yıldırım, Altın, & Yalçın, 2005).

2.5.2. Curriculum Development in VET

Curriculum theorists reach a common consensus on curriculum design patterns that may be used to conceptualize the curriculum-planning process: the academic pattern, the competencies (technical/utilitarian) pattern, the experiential pattern and the pragmatic pattern. In vocational and technical curriculum development, traditionally the competencies (technical/utilitarian) design pattern is the heavily followed framework (Herschbach, 1992) (Finch & Crunkilton, 1989). Thus in this part, the historical advance of competencies design pattern and the essential models of this pattern will be explained.

When vocational and technical curriculum is constructed following competencies design pattern, its distinguishing characteristics can be reflected to the instruction effectively. The subject matter of vocational curriculum is derived from technical activities differing from formal subjects such as biology or history. Therefore, the competencies design pattern with its *performance-oriented* structure is best fitting vocational curriculum. Moreover, this design pattern emphasis on the importance of students' individual differences and background knowledge. Accordingly in

order to provide curriculum efficiency, curriculum delivery system (Teaching methods, activities, materials etc.) should be arranged based on these specialities (Herschbach, 1992).

Basically, the entire educational milieu is a system from the competencies design pattern viewpoint. A system is a collection of elements, interacting with each other to achieve common goal in general definition. In our case, the key system is educational system and it is described as organizing interrelated components to form a whole for reaching educational objectives. The educational system has unique characteristics similar to every system. Firstly, the components such as students, school, learning activities etc. should be connected to each other properly for a successful implementation. The system should also have a vital objective so as to arrange the components to accomplish this objective (Sezgin, 2000).

In **Figure 8**, the vocational education system is briefly shown with its fundamental components: students, vocational program, graduates and feedback. Students entering the system represent input and the graduates represent output of the system. Assessment of the graduates functions as feedback for the modifications. Furthermore school, industry, community etc. are the external factors that can influence components of the system so they represented as the environment effects in the figure.

The systematic design of vocational and technical curriculum based on competencies (technical/utilitarian) design pattern has a rich tradition. Firstly in 1919 Charles Allen proposed in his work that effectiveness of instruction depends on not only the ability of instructor, but also the quality of the design due to the its guiding function in planning, conducting and evaluation phases of instruction. Following work by Selvidge in 1923, stressed on same opinions with Charles Allen and provided an effectively way for design of instruction. In this way the first step is determining objectives by considering the skills, attitudes and habits that are expected from a vocational graduate. The second step is analysis of the occupational field in order to determine its major specialization areas. The next step is selection of proper specialization areas appropriate to the general objectives, students' characteristics and available equipments. The last step is formulating content based on the following themes: "things students

should be able to do” (operative skills), “things students should know” (information necessary for successful performance of the skills), and “what students should be” (attitudes and habits necessary for successful performance) (Herschbach, 1992).

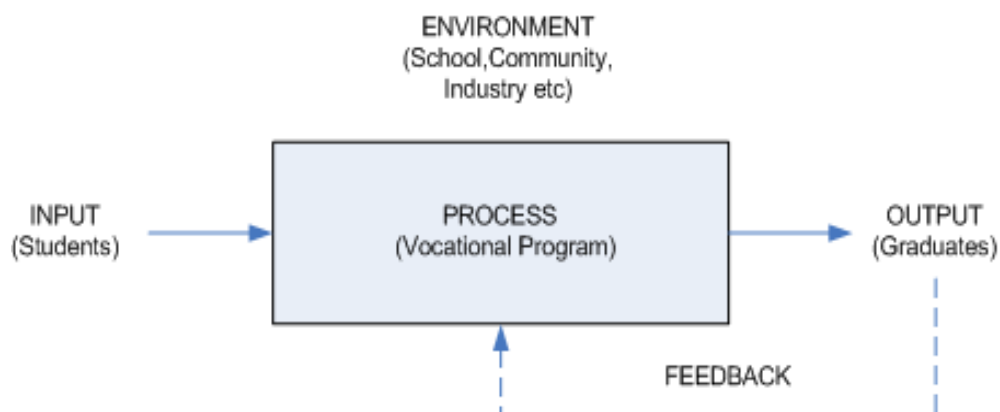

Figure 8. Vocational Program System

(Source: (Finch & Crunkilton, 1989))

The systematic design of instructional programs applied during World War II for training military personnel and production workers. After the war, private industry also attempted to improve quality and productivity by formulating and implementing instructional system models. In this period of time, researchers heavily focused on similar fundamental steps to design training programs. The first step is analyzing the job in order to detect job requirements and deriving training requirements from job requirements. The observable and measurable objectives are specified based on these requirements. The next step is arrangement of teaching-learning activities. And the last step is measurement of learning outcomes and the evaluation the efficiency of system components.

In 1970s vocational and technical curriculum development evolved and applied in public education in addition to military and private industry trainings. The application of learning theory and educational technology began to influence vocational curriculum designs in 1980s. The significant vocational and technical curriculum designs based competencies pattern are represented by models as

follows.

Model of U.S. Army Institute for Behavioural and Social Sciences

Model of U.S. Army Institute for Behavioural and Social Sciences is commonly accepted and applied model by the U.S. Air Force in the early 1970s and by the U.S. Army in the mid-1970s to design military technical trainings. This model is called as instructional system development model (ISD) and basically comprised of five phases: analyze, design, develop, implement, and control. The sub-stages of the phases illustrated in detail in **Figure 9**.

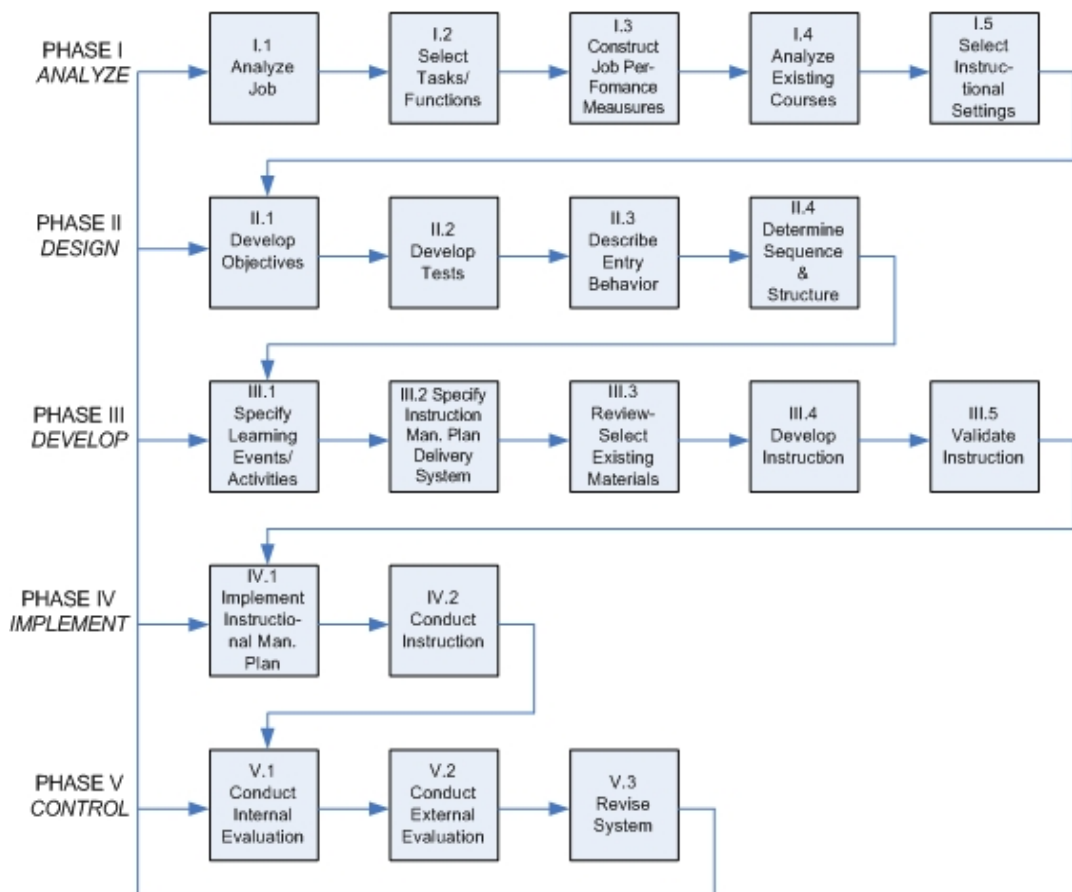

Figure 9. The Instructional Systems Development Model

(Source: (Finch & Crunkilton, 1989))

The instructional system development process starts with an analysis of tasks performed on the job and continue with the developing and sequencing objectives

based on determined tasks in the design phase. In this phase students' entry behaviours analyzed in order to individualize instruction as well. The next phase, development, is comprised of identifying learning activities, delivery system and instruction. These events are described considering the questions "where the instruction will take place", "What are the available equipments, materials" etc. on an instructional management plan in the implementation phase. The final phase, control, focuses on evaluation of components of system and the whole system as well and performing required modifications up to this evaluation (Finch & Crunkilton, 1989).

Model of Richard Swanson

This model is developed in 1978 by Richard Swanson and called as Training Technology System (TTS) .He stressed on that economic improvement is tied to the efficiently and effectively managed education. Although the model is formulated for industry and business use, it can be applied in vocational and technical education programs as well. TTS model is comprised of five phases like ISD model: analyze, design, develop, implement, and control as represented in **Figure 10**. However it has distinguishing differences in sub-steps.

Firstly in TTS the analyze phase begins with needs assessment for determining the organizational needs and exploring solutions to the causes of these needs. Then analyzing the work behaviours serves a base for the rest of the system. The second phase, design, constituted of lesson designs, which forms a program design at the end. Lesson designs focus psychological aspect of the training and structured adequately assembling of the components: objectives, content structure, and instructional sequence, date of delivery, repetition and practice, reinforcement and rewards, and knowledge of results.

The development phase differently from ISD model, include pilot testing of training program. This step provides detection of deficiencies and may serve a base for revisions of materials and lesson designs. Next phase, implementation, includes preparation of a program management plan and delivery of training. The last phase, control, incorporates common evaluation and follow-up processes (Finch & Crunkilton, 1989).

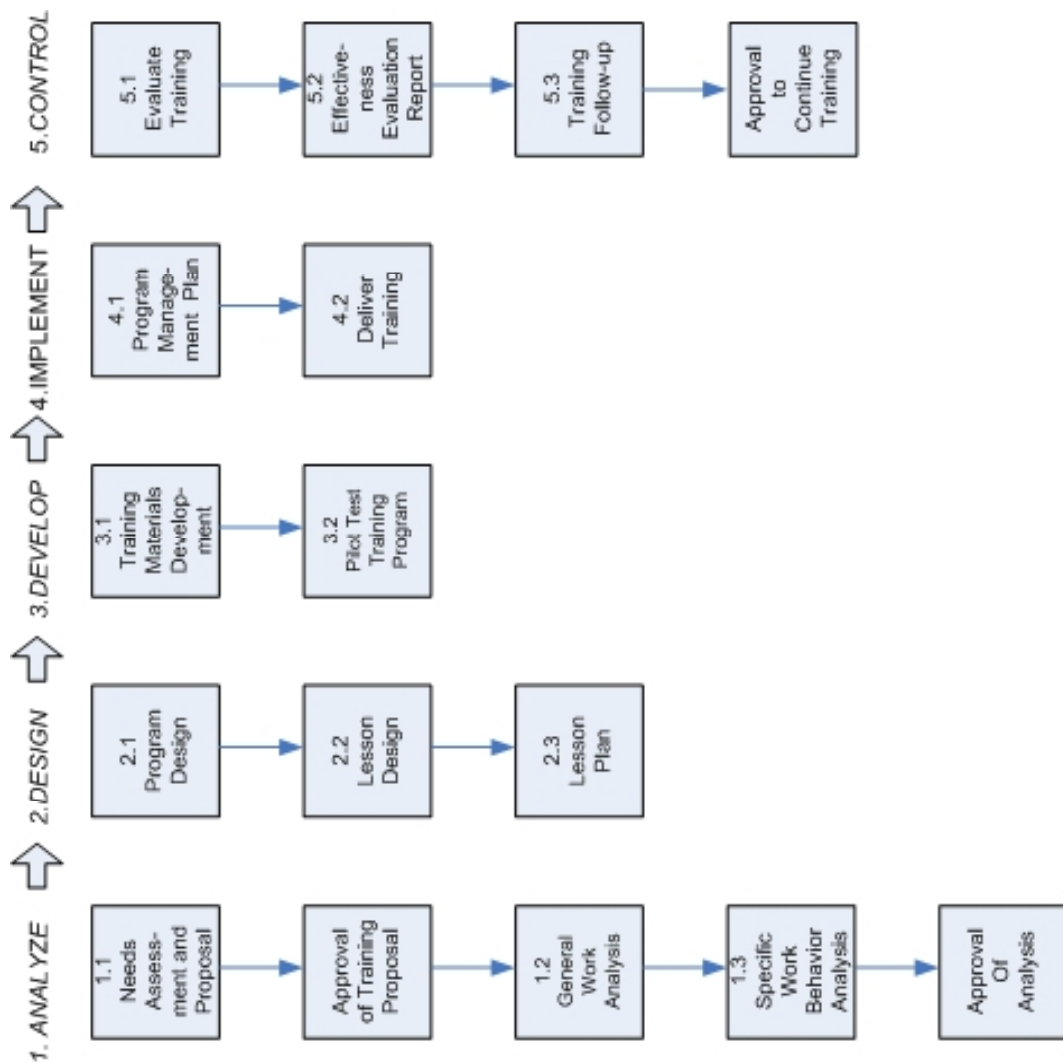

Figure 10 Training Technology System

(Source: (Finch & Crunkilton, 1989))

Model of Popham, Schrag and Blockhus

Popham, Schrag and Blockhus designed a curriculum development model in which the teaching-learning process handled as a competency based system in 1975 shown in **Figure 11**. This model is a progressive one means each step is constructed on the previous one. The significant feature of the model is it focuses on student achievement and feedback. First of all, in order to identify and classify competencies, learners and business needs are determined as the inputs of the

system. Next, evaluations are planned as an early effort and afterwards performance goals are constructed. Then, learners are pre-tested for selecting proper learning principles and teaching-learning strategies for them. Finally student achievement and system effectiveness are evaluated. As a result of this evaluation if a student achieves mastery of a performance goal, he or she continue with the next goal. If not, necessary revisions are performed and the system is operated again (Sezgin, 2000).

Arrangement of vocational and technical education programs based on system view, provides determination of the scope of the program according to the needs of individuals, adaptability of the curriculum up to the innovation in industry and as a result of this detection properly identification of educational standards and resources (Sezgin, 2000). Although there is not a clear distinction between curricular systems and instructional systems in the represented design models, they are valuable to picture the components and their relationship in a vocational system and beneficial for development of effective vocational and technical curriculum

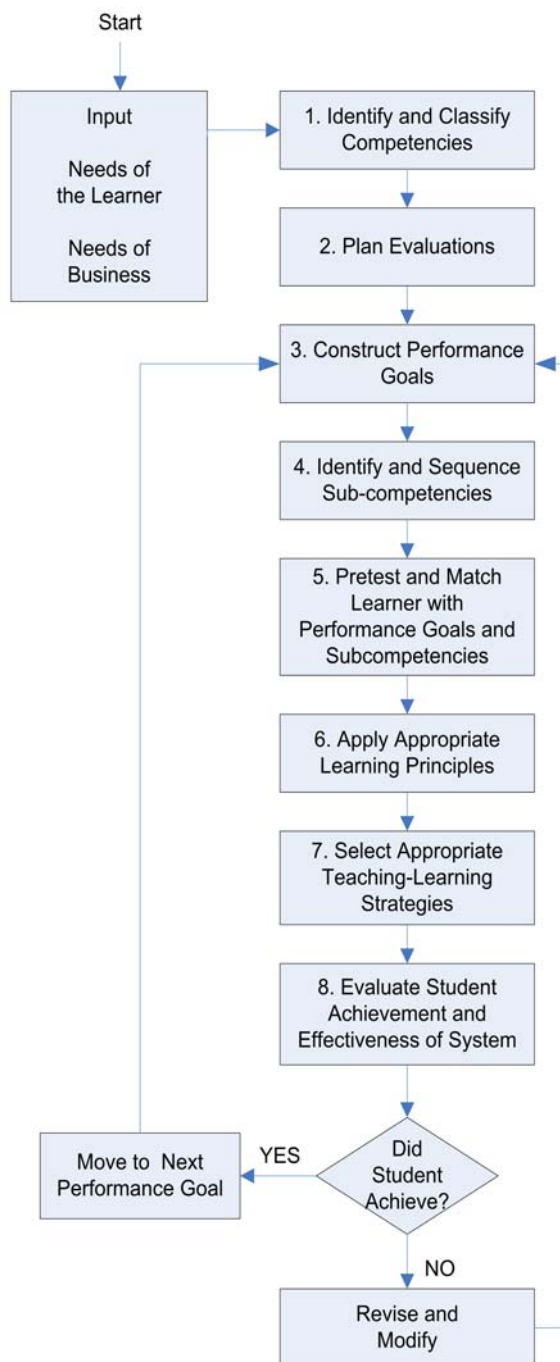

Figure 11. A Teaching-Learning System

(Source: (Sezgin, 2000))

2.5.3. Competency-Based Modular VET Curriculum

Vocational Education and Training System in Turkey, newly adapted to a competency-based framework and the vocational curricula are organized into

instructional modules. In this section first of all the scope of competency-based education (CBE) and modularization of instruction will be examined, before describing the curricular processes of the system in detail.

The core of the CBE is competency. A competency is introduced as a state of being adequately or sufficiently qualified to perform a task that is reasonably well defined. The International Board of Standards for Training Performance and Instruction (ibstpi), defines competency as an integrated set of skills, knowledge, and attitudes that enables one to effectively perform the activities of a given occupation or function to the expected standards (Spector, Klein, Reiser, Sims, & Knowledgecraft, 2006). Something performed by a worker does not mean that it can be classed as a competency; in order to meet the standards of an occupation it should be a critical aspect of employability in an occupation.

Accordingly, the competency-based education is a form of education that derives a curriculum from an analysis of a prospective or actual role in modern society and that attempts to certify student progress on the basis of demonstrated performance in some or all aspects of that role (Biemans, Nieuwenhuis, Poell, Mulder, & Wesselink, 2004).

The competency concept in education has meaningful objectives such as individualization of instruction, usage of instructional technology and systematization of delivery and management of instruction so as to prepare students to function effectively in the world of work. The usage of the concept of competency for the vocational and technical training development is very popular in European Union countries and USA as well nowadays. The essential idea resulted this popularity is the expectation that competency-based education diminishes the gap between labour market and vocational education.

Furthermore in consistent with the principles of life-long learning, competency development continues through an individuals working life in order to reach the rapidly evolving skill requirements of industry and society. Here at this point, capabilities are important for graduates of vocational schools in employability instead of acquiring a diploma degree. Therefore, the emphasis shift to developing capabilities will improve the link between labour market and vocational education

(Biemans, Nieuwenhuis, Poell, Mulder, & Wesselink, 2004).

Actually the competence-based education and training have a long history. Researches on this topic grounded three basic approaches: the behaviourist, the generic and the cognitive. The behaviourist approach emphasized the importance of observing successful and effective job performers and clarifying what distinguish them from their less successful counterparts. According to the behavioural approach demonstration, observation and assessment of a competency is critical. Thus competence-based education should start with a task analysis in which jobs are broken down into single tasks.

The generic approach, on the other hand, intended to identify the common abilities that explain variations in performance (Mulder, 2007). The essential characteristic of the generic competency is its sensitiveness to work context changes. Generic competencies are the ones that are framing an overall performance. According to the cognitive approach, competency includes all of the mental resources of individuals that are used to master tasks, acquire knowledge and achieve a performance. Furthermore there are also many other approaches that categorize competencies in the research literature but here the most comprehensive ones were introduced. (Biemans, Nieuwenhuis, Poell, Mulder, & Wesselink, 2004).

Identification of the competencies that are critical to effectively performance in a particular job begins with definition of job's role and continues with the detection of the current practices and existing standards in the light of ethics and future vision. Then validated skills, knowledge and attitudes are expressed as performance statements. This competency development model originated by The International Board of Standards for Training and shown in the *Figure 12* (Spector, Klein, Reiser, Sims, & Knowledgecraft, 2006).

Due to the nature of the competency, competency-based vocational education has distinguishing characteristics from traditional instruction. As illustrated in the figure, there should be standards associated with each competency. Standards are needed criteria to assess students' exhibition of a competency. This assessment process should focus on application of competency in an actual work setting.

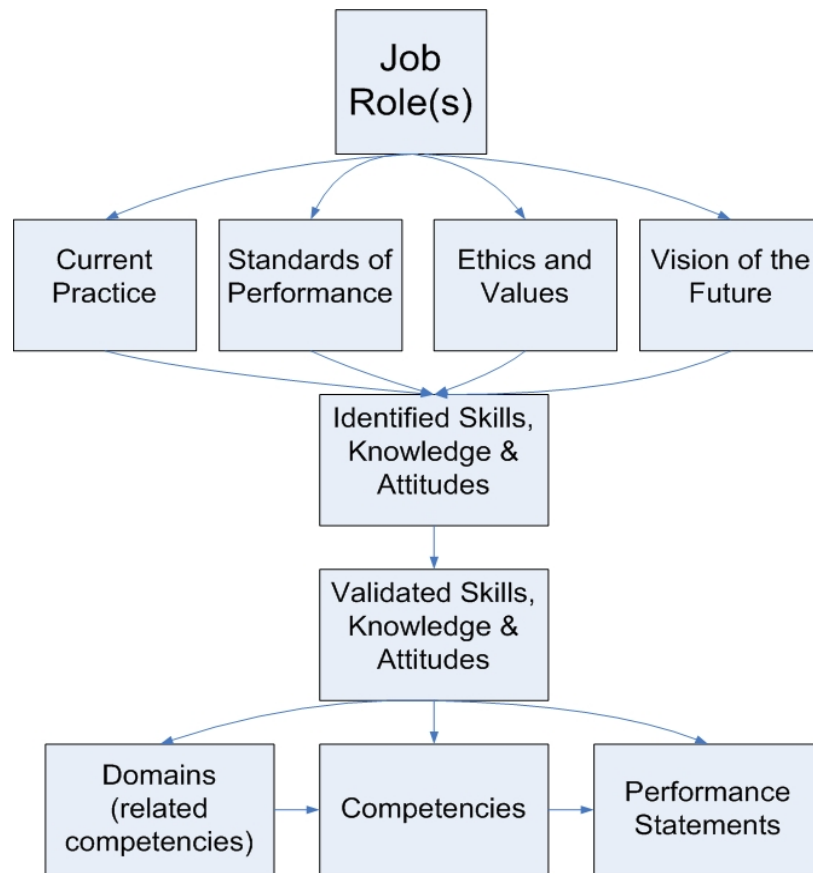

Figure 12 .The ibstpi Competency Development Model

(Source: (Spector, Klein, Reiser, Sims, & Knowledgecraft, 2006))

Another important feature is competency based vocational curricula should not be organized into strictly time quarters such as terms, weeks etc. In CBE student is determiner of a program completion. Hence students have the flexibility to progress through a program at their own rates depending on their individual abilities (Finch & Crunkilton, 1989). If the competency-based vocational curricula arranged into modularized instruction, it directly focus on individual needs and development of job specific competencies. In the following section, the properties and the advantages of modularization will be discussed in detail.

2.5.4. Modularization of Instruction

Modularization of instruction is to organize instruction in a way that will be constituted of modules as the basic instructional building blocks. Modularization is recognized as an approach that improves effectiveness of vocational

education and training system by offering a flexible framework reactive to economic, technological and social innovations and individual characteristics as well. Modularization combined with CBE, is raised up a useful method of reorganization and modernization of vocational education and training in all over the world. This concept firstly evolved in higher education in the United States during the second half of the nineteenth century and then spread out the Europe (De Bruijn, 1995).

Modules are small packages of course content, which have logically self-integrity and functional linkages to each other as shown in *Figure 13*. These instructional packages are constituted of planned learning experiences to enable students learning individually through specified objectives. Modules are not only used for grouping of the content such as units or lessons in conventional curriculum design. Each module is a constituent part of instruction, which contains its own objectives, learning and application activities, assessment questions etc. associated a competency in it (Düzcükoğlu, Asiltürk, & Yaşar, 2005).

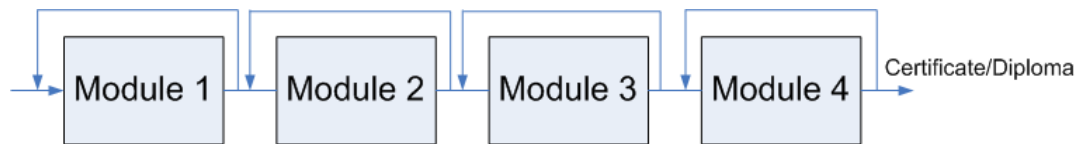

Figure 13. Modularization of Instruction

(Source: (MEB-MEGEP, 2005))

Modules have certain characteristics that distinguish it from an ordinary instructional package. First of all, modules are self-contained. This means that without an instructor students can progress through modules by using directions. Competency requirements of labour markets are evolving rapidly. They demand vocational graduates to master a broad skill spectrum including general and occupational ones. In order to be successful in this evolving work environment, vocational students should acquire the skills such as research and learning to learn. Here at this point thanks to modules' self-contained, individualized structure because they are the excellent way of comprehending these generic abilities. Next,

modules are self-pacing. They offer students to continue at their own rates depending on their personal abilities without any time constraints(MEB-MEGEP, 2005).

Modules are the guides for students and also for teachers. Modules include learning experiences to actualize a measurable objective related to a competency. At the end of each module assessment questions are offered to students for providing immediate feedback and evaluation if they achieved specified standards. Additionally, a module includes the information of prerequisite skills and needed equipment and materials. With all these properties modularization provides individualization of instruction. Students are responsible for their own learning and teachers act like a facilitator to assist them if needed (Finch & Crunkilton, 1989).

The mainly advantage of modularization of instruction is it supports flexibility of individuals, curricula and educational pathways. It is easy to adapt the modularized vocational curriculum up to the rapidly changing skill demands of industry through the coherent structure of instruction. Therefore with modularization, vocational curricula became more responsive to the local labour market and community needs. Resulting from this, the linkage between industry and vocational education will be stronger (Cornford, 1997).

Moreover, the modularization of instruction supports flexibility in educational pathways by enabling opportunities to transition between general and vocational high schools and within the vocational high schools. Furthermore at the end, by enabling certification system, students will handle the flexibility of quitting or entering the system depending on their acquired modules.

Actually besides all the advantages of modularization, it has some necessities for adequately implementation. Firstly, vocational students should have the ability of learning individually through the modules and this type of instruction should be their preference. Hence modules should be structured in a way that supports individual study. Next, the teachers should be aware of the differentiation in their role compared with the conventional instruction thus they should arrange the learning environment in accordance with the student centred activities. Hence the learning environment should include the resources and materials that will facilitate

individual progress. Consequently, MoNE should support modularization of instruction with huge investments because it requires comprehensive arrangements and infrastructures as well.

2.5.5. *Implementation of Competency-Based Modular VET Curricula in Vocational High Schools in Turkey*

After introducing the fundamentals of CBE and modularization of instruction, in this section the new framework of initial level VET curricula will be described in detail. This description will be performed through following the recommended curriculum development model of SVET project, shown in **Figure 14**.

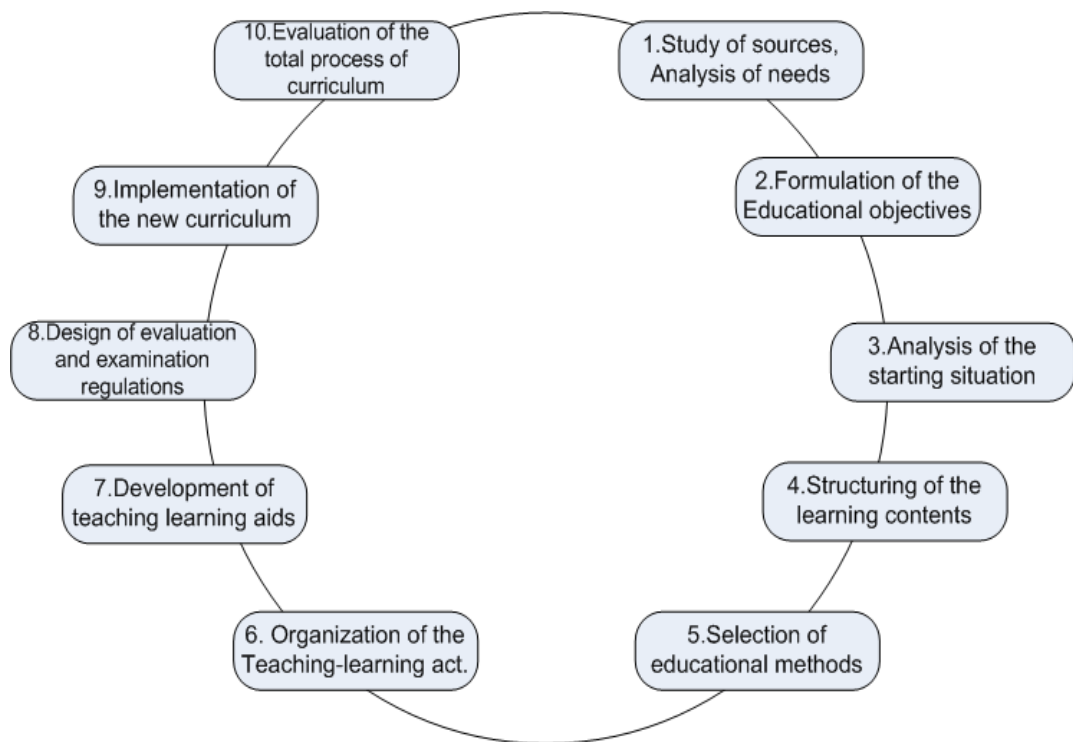

Figure 14. Periodic activities of curriculum development

(Source: (MEB-MEGEP, 2003c))

1. *Study of sources, Analysis of needs*

VET Curriculum development process begins with the investigation of community and labour markets as an input of the system. Resulting from these analyses new occupational profiles are specified which supply the demands of national and international assets such as computer technical service, accountant, electrician etc. These occupations are grouped based on their labour sector. For example the focus sector of this study, Information Technologies, includes four occupational profiles: computer technical service, network management, database programming and web programming. Currently, 42 sectors (area) are and 197 related occupational profiles (departments) are identified in vocational high schools within this scope.

After determination of occupational profiles, skill needs analyses performed in order to identify common area competencies and departmental job specific competencies. Skill needs analyses are shaping an interface between the labour market analyses and occupational standards on one side, and educational standards and curriculum development on the other side. Thus the rest of the design process such as standards and objectives are constructed upon this analyses step. Here the intention is bridging the gap between vocational education system and the industry (MEB-MEGEP, 2003d).

The next action is formulation of occupational standards (OS) based on labour market and skills need analyses. Occupational standards are the linkage between world of work and world of education. Both labour market and vocational education system benefit them. OSs are useful for systematizing the work more effectively and transparent in sector and also development of vocational curricula are actualized with the guidance of them. MSK (Occupational Standards Commission) is the responsible body for production of these standards. MSK is a tripartite decision-making body comprising representatives from the government, employees, and employers. An occupational standard is developed for a specific occupational profile and comprised of core duties, competencies, skills and attitudes of jobs. Additionally, success and assessment criteria of competencies and infrastructure requirements for effectively implementation of competencies are specified within the OSs. The main construction objectives of OSs' can be summarized as providing occupational skill certificates to vocational graduates

depending on achieved competencies and by this way enhancing graduates mobility.

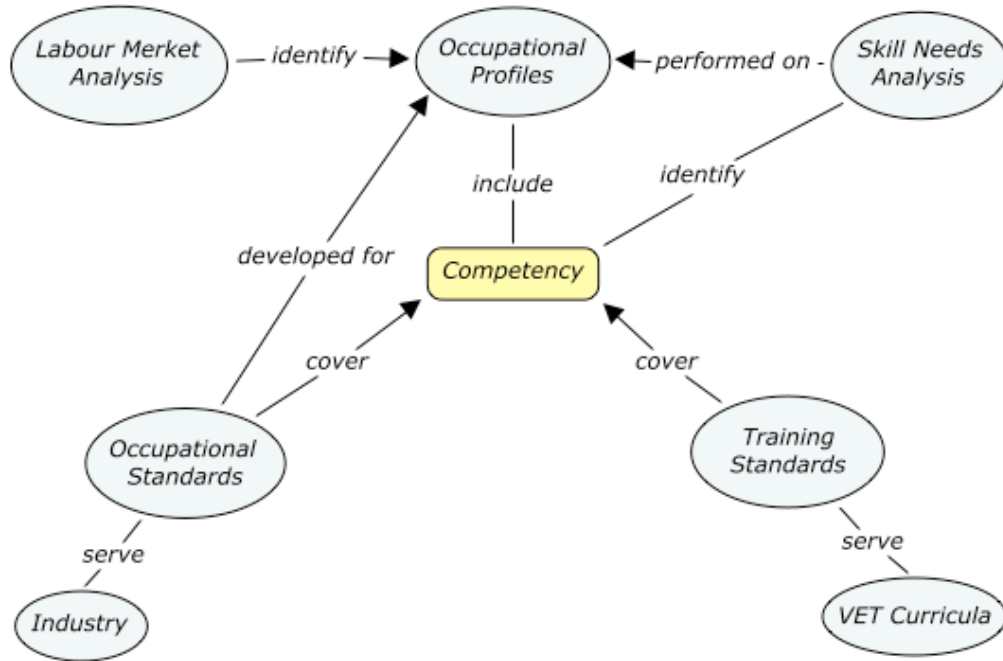

Figure 15. Schema of VET system elements

Actually occupational standards heavily serve the demand side of the VET system. At this point training standards (TS) are required for the supply side, vocational high schools, of the system. They are derived from competencies specified for an occupational profile in OSs and the rest of the vocational curriculum development process is assembled upon them. Training standards are developed central administration of METARGEM (Vocational and Technical Education Research and Development Centre) and cover the ingredients such as definition of occupational profile, prerequisites, duration of training, employment conditions, job specific competencies and the level of training based on National Qualification System (NQS). The mainly objective of formulating training standards is to support internationally transparent VET qualifications and by this way improving vocational graduates mobility and credit transfer in Europe (MEB-MEGEP, 2003d). The elements explained in this section are pictured together with their

connections in *Figure 15*.

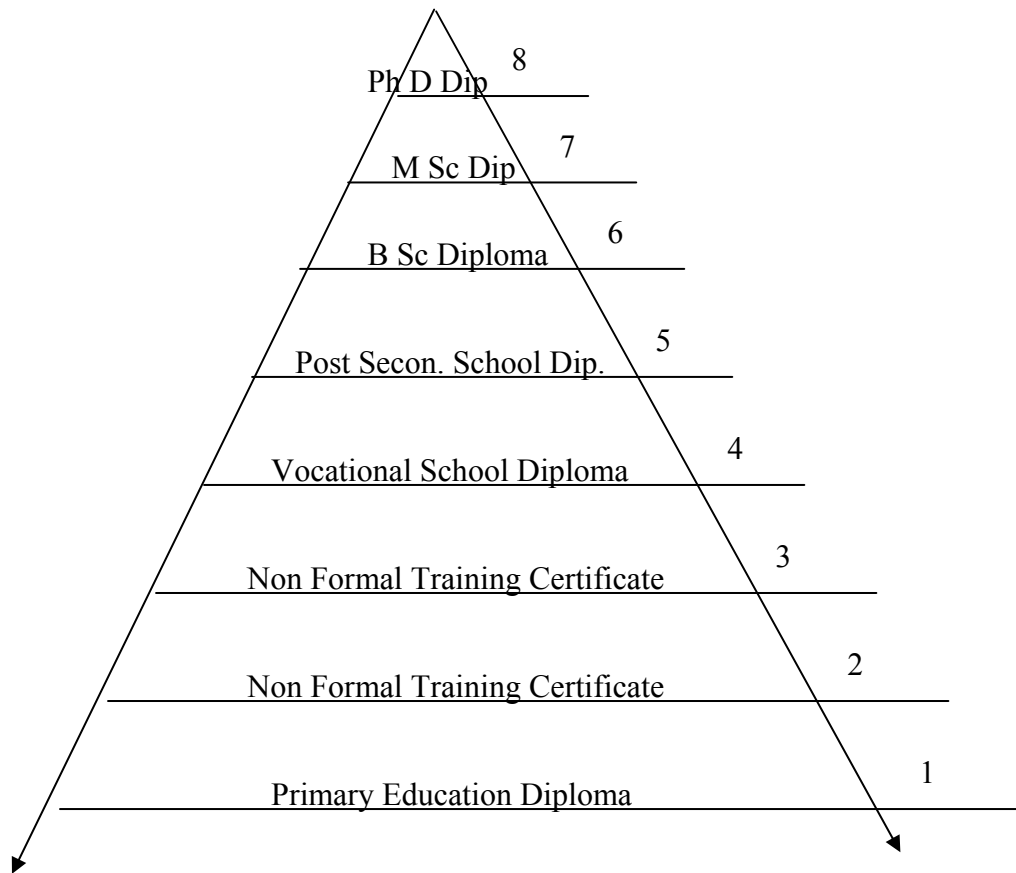

Figure 16. 8 Level NQF of Turkey

(Source: (Yalçın, Yıldırım, Altın, & Borat, 2005))

National Qualification System (NQS) is a framework that provides certain qualification criteria constituted of 8 levels. MoNE accepted this 8 level NQS with the involvements of social partners including representatives of employers' and employees' confederations. The standards of occupational profiles' in vocational and technical high schools is fitting level 4 as shown in *Figure 16* (Yalçın, Yıldırım, Altın, & Borat, 2005). The legal responsible body for the implementation of NQS in Turkey is MSK (Occupational Standards Commission). MSK is responsible for development of standards and assessment of candidates whether they have met the standards. Resulting from of this assessment, candidates are awarded with certificates (MEB- MEGEP, 2003b).

NQS offers identification of qualifications across European Union and within the country as well. Candidates have opportunities to transfer between institutions and occupations within institutions or certain professions with these validated qualifications. The development of NQS provides a less complicated and more efficient VET system by focusing a smaller number but more broad-based qualifications adaptable to the changing work environment. Additionally, NQS offers to ensure that all the qualifications are well designed and fitting the purpose of flexible competency-based vocational curricula (MEB-MEGEP, 2003a).

2. Formulation of educational objectives

Next step of the VET curriculum development process is conveying the competencies specified in TSs into educational objectives. An educational objective is expressions of a learner's intended potential behaviour that will be succeed after an educational activity. VET curricula focus on cognitive and psychomotor domains of behaviour when formulating objectives. However as these curricula are not only covering vocational skills, but also they comprehends common generic skills. Hence affective domain should also be considered. The objectives should be constituted of a balanced harmonization of these three domains.

The educational objectives that will be formulated in this step called as concrete objectives. Concrete objectives are formulated in controllable terms the degree of knowledge, skills or attitudes of a learner at the end of a lesson, a module, a learning activity. They are the third level in the objectives framework. The level of objectives and their relations are pictured in *Figure 17*.

The first level in the objectives framework is general (national) objectives. They express the values and needs of society and answer the question that for what the education system serves as a whole. For instance, the general objective of our initial level formal VET system is: Preparing students both for their occupation life and higher education based on their interests, talents and capabilities (MEB, 2002). Intermediate objectives are formulated for expressing the intended educational results at the end of a certain educational phase or training considering the general objectives. They are specific to a sector, an occupational profile, school or a

certain course. For instance, the intermediate objective of web programming occupational profile is: Training blue-colour employee who has the qualifications of computer hardware and software installation, web page designing and developing interactive web pages with using programming languages (MEB-MEGEP, 2007a).

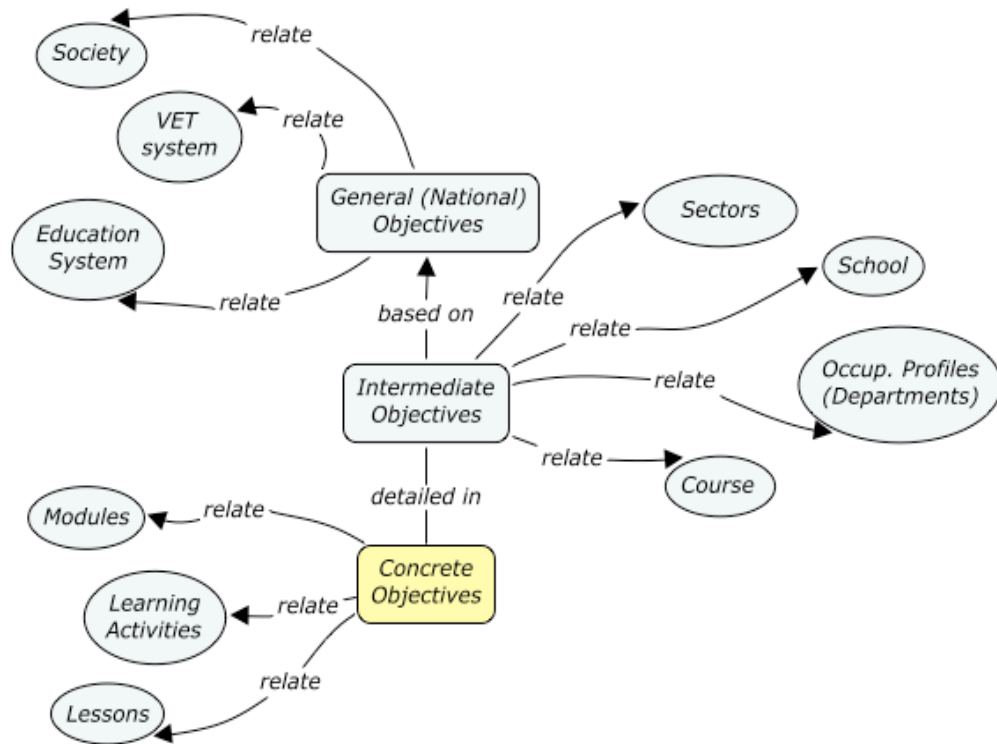

Figure 17. The Objectives of VET system

Intermediate objectives are detailed in concrete objectives. Concrete objectives cover the clearly statements of knowledge and skills and offer the opportunity to assess the results of education. For instance, one of the concrete objectives of module “principles of direct current” is: Students should be able to measure the voltage magnitude of resistors in a serial electrical circuit by using a digital voltmeter.

3. Analysis of the initial starting situation

The third step covers examination of the preliminary situation of students, teachers, schools' infrastructure and national legal framework to constitute a base for the rest of the curriculum development process. For instance structuring the instruction on modular basis, selecting of educational methods, arranging teaching-learning activities, and determining the needed in-service teacher training activities etc.

Preliminary situation of students includes the investigation of their initial personal characteristics such as age or sex, personal abilities and logic thinking and abstraction skills considering their educational level. Furthermore, national language and foreign language skills, cultural standards of society and families and socio economic conditions are also important for picturing the preliminary starting situation of students.

Next analysis, preliminary situation of teachers starts with the determination personal characteristics of teachers such as age, social background and continue with the analysis of professional and pedagogical characteristics such status of vocational and pedagogical education, working experience, skills required for implementing new curricula and using educational technology, etc.

School's infrastructure circumstances are the other significant consideration in vocational curriculum development process. Before the organization of teacher-learning activities, infrastructure appropriateness should be investigated that are needed for successfully implementation of a planned curriculum. These are presently laboratories and workshops of school, equipments and materials, available budget, managerial organization of the school etc.

The last and the critical analysis is national legal framework. The new competency based vocational curriculum requires a more flexible legal framework in order to support the actualization of new reform in consistent with its objectives. Hence the present laws and regulations should be examined in this step and as a result needed modifications should be adapted.

So far, the first three steps of VET curriculum development model shown in **Figure 14** were described. The next four step, 4. 5. 6. 7., will be handled together

under the title of “the teaching learning process” since there are strong interrelations among them.

4. 5. 6. 7. *The teaching learning process*

The learning contents, educational methods, teaching-learning activities and materials are the associated stages of curriculum development so they should be handled together for building a successful VET curricula framework. All the actions performed in this broad phase are constructed upon the defined educational objectives in the light of initial starting situation as illustrated in Figure 18.

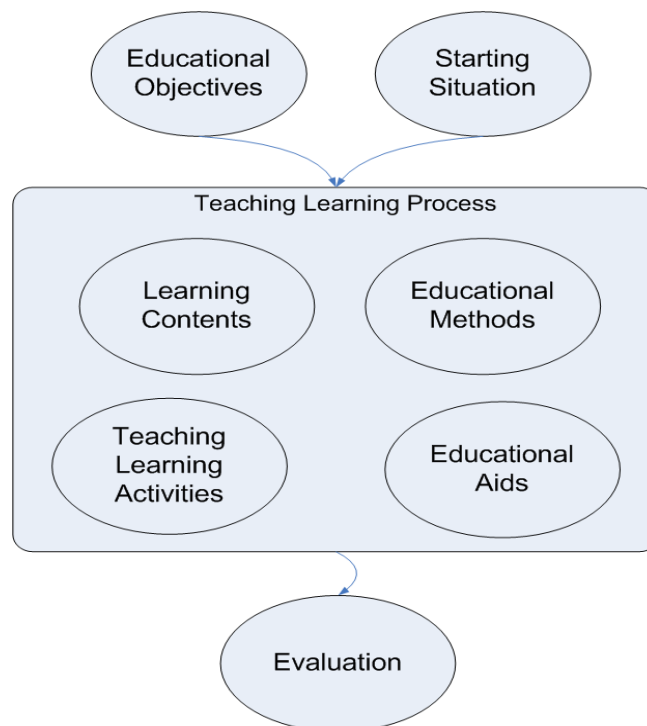

Figure 18. Teaching Learning Process

Firstly, the learning content is determined and structured based on the specified objectives. As the instruction is on modular basis, the sequencing and presentation of the content should be performed based on its principles. The whole learning content for an occupational profile is divided into small independent learning units “module”. And each module is associated to a competency and a concrete

objective in consistent with training standards of specific occupation.

The rest of the organizational activities such as preparation of year programme, lesson plans etc. are introduced as instructional planning activities and held by school personnel and sector representatives. The aim of the modularized instruction is reflecting local industry and community needs to VET education, thus each school should plan its own instruction. By considering the initial starting situation, schools select occupational profiles and courses and prepare year programme. Furthermore also they have an opportunity to select among modules, to add new modules and to update the modules. However for providing common occupational qualifications to vocational graduates within the country context, the training standards should be taken into account.

A module contains an introduction part, core content, applications and exercises for practice and it is divided into learning activities. There is an assessment and measurement part at the end of each learning activity for students' self progress. Additionally, to assess the students' achievement on a module totally, teachers evaluate them with a performance test considering the specified criteria of a rubric. When it has been proven that the student has concluded the module and he may continue with the next one.

The selection of educational methods is also important, because a truly selected method provide strong linkages between teacher and students and provide the efficiently usage of teaching learning materials. Our new competency-based VET system focuses on qualifications and aims to adopt the students to principles of lifelong learning. Accordingly, problem-based learning, cooperative learning, project-work, demonstration, case study and brainstorming are the recommended methods. Teachers are the responsible bodies to select and implement the appropriate educational methods. They will plan it based on the objectives and initial stating situations and with respect to the modules' learning content and timing.

The last step of teaching-learning process of VET curriculum development is materials. The fundamental material of modularized instruction is a module. Hence before initiating the instruction process in schools, all the modules should be ready

and easily reachable by teachers and students. Moreover, in order to successfully implementation of the instruction the module specific materials should be ready to use in schools. Other resources books, multimedia devices should also be ready and the classroom environment should be arranged in a way that students can easily access them.

- *Design of regulations for evaluation and examination*

This step covers the description of students' assessment processes. Due to the modular structure of new VET system, evaluation framework should be adaptable to its context. Thus each module has assessment part as the basic level in order to measure students' qualification on specified competency. Students should succeed this competency to continue with the following one through the course. Graduates have an opportunity to get a certificate based on their achieved competencies and leave the system early, in accordance with the flexibility principle of the modularized instruction. Otherwise, they continue training for four years to have a vocational school diploma. Hence the evaluation and examination regulations should be reformulated appropriate to the competency based modular system fundamentals (MEB, 2004).

- *Implementation of education and training*

The implementation step, action phase, should be started with the preparation of an implementation plan and before initializing implementation, all the previous steps should be carried out successfully.

The new competency based modular curriculum in Turkey began implementation in the academic year 2005-2006 with a national project MEGEP. Pilot implementations were performed for early evaluation and adaptation one year before starting in five cities from different regions of Turkey: Ankara, Antalya, Gaziantep, İstanbul, İzmir and Trabzon.

- *Formal evaluation of total process*

The results of the new reformed VET curriculum should be evaluated in a formal way in national context considering the vocational schools and labour markets. External experts based on a plan should perform this evaluation and vocational

students, graduates and employers should be included in this process.

Evaluation in VET topic will be examined in the following parts in depth, as this work is an example of an assessment effort.

2.5.6. Curriculum Evaluation in VET

Evaluation is gathering of empirical evidence for decision-making and the justification of decision-making policies and the values upon which they are based (Glass, 1968). Curriculum Evaluation is the set of activities performed for gathering information on the process and outcomes of programs, curricula or courses (Gredler, 1996). It is an important way of assessing if a program is functioning in actuality as it was intended. And as a result it supports improving the quality of program up to the identified weaknesses (Erozan, 2005).

Glass (1968) states the goal of curriculum evaluation as to respond the matters of selection, adoption, support and the worth of the educational materials and activities. It examines whether the program succeed to reach its intended outcomes and is there a logical consistency between the instructional activities and the program philosophy and goals. Therefore, it plays a vital role in innovation and improvement of the program (Hamilton, 1977).

Curriculum evaluation was classified into two main categories according to the intention of evaluation context that defines the purpose of plans and actions: formative evaluation and summative evaluation. Formative evaluation is employed during the development of a program with the intention of improvement. It aims to give advice to the program planners and developers on insufficient issues. Therefore, formative evaluation provides early identification of program deficiency before they cause major problems (Westbury, 1970) (Baker, 1969). Summative evaluation, on the other hand, takes place at the end of a program to arrive a general conclusion. It aims to assess the whole program in order to detect the success and effectiveness. This recognition results a critical decision on whether to continue or terminate the program (Topçu, 2005).

There are several curriculum evaluation models in the literature depending on the context of evaluation. With this regard, Gredler (1996) classifies different models into two main categories depending on their viewpoint on the role of

evaluation, served audiences and data results: Utilitarian perspectives and Intuitionist/Pluralist perspectives.

- Utilitarian perspectives: This approach considers a predetermined decision maker as the audience for an evaluation such as administrators, policy makers, school boards, teachers etc. The evaluation processes totally build up upon predetermined standards. The result reports consisted of data related to the whole system. Provus's (1973) discrepancy evaluation model, CIPP (Context, Input, Process, Product) evaluation model, Stake's Countenance Approach (1967), and Scriven's goal-free perspective (1972) can be listed under this approach.
- Intuitionist/Pluralist perspectives: In this evaluation approach, in contrast to the Utilitarian perspectives, information needs of individuals associated with a program are considered instead of key decision makers. This approach views evaluation broader so that evaluation processes do not rely on uniform standards. In order to mirror various points of program, experiences of different groups can be included in the study for altered intentions. Eisner's educational connoisseurship and criticism approach (1977), Stake's responsive evaluation perspective (1967) and Parlett and Hamilton's (1976) illuminative are the important examples for this approach.

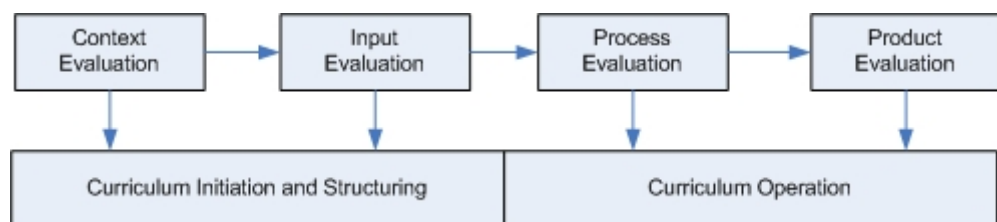

Figure 19. A Framework for curriculum evaluation

(Source: (Finch & Crunkilton, 1989))

Curriculum evaluation is the vital and integral component of an ongoing curriculum development process. Since the curriculum development is a

systematic process, curriculum evaluation efforts should follow a meaningful structure as well to support its integrity (Finch & Crunkilton, 1989). The new contemporary vocational curricula, on the other hand, are completely complex, thus they require comprehensive evaluation efforts to assess different aspects of initiation and implementation. Finch & Crunkilton (1989), portrays an evaluation design for vocational and technical curricula that was constructed based on CIPP model as shown in Figure 19.

The four elements of the model are: Context evaluation, Input evaluation, Process evaluation and Product evaluation.

1. *Context evaluation*, aims to characterize the learning environment that the curriculum will be enacted. It detects the needs, drawbacks and advantages of environment. Decisions resulting from collected data will provide a basis to decision makers for establishing goals and priorities and spotting required changes (Stufflebeam, 2000).
2. *Input evaluation*, tries to systematically investigate and assess capabilities of an educational organization, resources for accomplishing program objectives and implementation plans (i.e. action plans, staffing plans, and financial plans) for their feasibility and probable cost-effectiveness. The concerned resources can be teaching and learning strategies, environment, program modules, equipments and materials. Decision makers use evaluation results in allocating resources and staff, arranging works and finally judge the plans and budget to achieve curriculum objectives (Stufflebeam, 2000) (Finch & Crunkilton, 1989).
3. *Process evaluation*, directly take in hand program's implementation. It tries to answer the questions such as to what extent students have succeeded curriculum objectives or if the program is functioning adequately. Instructional staff use evaluation results to judge program performance and consequently, to improve it (Finch & Crunkilton, 1989).
4. *Product evaluation*, aims to assess program's quality. Hence it focuses on program graduates, as it is the end product of a curriculum. This evaluation occurs in a realistic work environment in order to determine the worth of

curriculum. Employers and supervisors can also be included in the evaluation as the data sources(Finch & Crunkilton, 1989).

2.5.7. Vocational Schools IT Curriculum in Turkey

The Information Technology Association of America (ITAA) defined Information Technology (IT), as the study, design, development, implementation, support and management of computer-based information systems, particularly software applications and computer hardware. It deals with the use of electronic computers and computer software to convert, store, protect, process, transmit, and securely retrieve information.

Information Technologies industry has become of the most robust labour markets in the world. IT is the backbone of nearly every major sector so that it is the key player of the global economic growth and productivity. It helps many other sectors in the growth process of the economy including the services and manufacturing sectors. The IT industry is knowledge-based dissimilar to other common industries. Therefore, efficient utilization of skilled labour forces in the IT sector can help an economy to achieve a rapid pace of economic growth. Because of these noteworthy characteristics of the sector, each country should make a strategic plan to take a place in the global IT market.

Parallel to this idea, our vocational high schools IT curriculum has been updated according to the industrial changes and labour market needs of world and our country as well, within the scope of project SVET. The MoNE, by implementing new vocational high schools curricula, aim to create a modern, flexible and high quality VET system and train blue-colour employee to meet current and future demands.

The new vocational high schools information technologies curriculum has been published by the decision of Board of Education numbered 324 in 07.09.2005 and began implementation in the academic year 2005-2006, after one year of plot implementation. Accordingly, the general objective of the IT area program is: Training blue-colour employee for predetermined occupational profiles whose qualifications meet the needs IT sector and, scientific and technologic developments (MEB-MEGEP, 2007a).

In the area of information technologies there are four main departments and each of these departments has its own definition and intermediate objective, therefore they have own sub-programs that constituted of departmental elective courses, departmental must courses besides common courses of IT area. These departments and their intermediate objectives are:

- Computer technical service

Objective: Training blue-colour employee who has the qualifications computer hardware and software installation, repairing and maintaining processes, conducting systems controlled by computer

- Network management

Objective: Training blue-colour employee who has the qualifications computer hardware and software installation, network systems installation, management and problem solving, management of wide area networks.

- Database programming

Objective: Training blue-colour employee who has the qualifications computer hardware and software installation, database management and programming language installation, database construction and management, software development, solving errors, maintaining and backup.

- Web programming

Objective: Training blue-colour employee who has the qualifications computer hardware and software installation, web page designing and developing interactive web pages with using programming languages (MEB-MEGEP, 2007a).

The new IT program is completely an innovation. Besides its updated content, it also provides students to specialize in one of four occupational profiles. Before this revolution, vocational high schools were implementing IT training mainly in two departments: Computer software and Computer hardware. Accordingly, the schools that linked to DG of Commerce and Trade Education and DG of Technical Education for Girls were mostly selecting computer software department and vocational high schools that linked to DG of Technical Education for Boys were selecting computer hardware department. The scopes of these two departments

were strictly diverged from each other and students were trained on one of them through three years.

On the other hand, according to the new system after completing the first year of program (common grade for both general and vocational high schools), students master common courses of IT area to make an initiation to the sector at the 10th grade. Then, they choose one of the departments of IT area by the end of this year and they continue with mastering specified competencies of their occupation at the 11th and 12th grade.

As a result, all vocational high schools implement a common IT curriculum depending on a general framework program. New IT program aim to reduce the diversity between vocational high schools, and to develop common IT skills among graduates besides departmental special ones. Therefore, it supports standardization and by this way adaptability of graduates into national and global IT sector.

There are four types of framework program for new IT curriculum depending on the type of vocational high school. Anatolian Vocational and Anatolian Technical high schools more stresses on the foreign language courses and Technical high schools stresses on general cultural courses (see Appendices A,B,C,D). Additionally, the training standards for four occupational profiles of area prepared by MoNE in order to form the boundaries of departments and give detailed information on competencies and required training conditions (see Appendices E, F, G, H).

The courses of IT curriculum grouped under three categories in these framework programs: common general cultural courses, common IT area courses and department special courses. Furthermore, for each department of IT area three must course are introduced. These are:

- Computer technical service department: Information Technologies Basics, System Maintenance and Repairing, Microcontrollers
- Network management department: Information Technologies Basics, Network Systems, Server Operating Systems

- Web programming department: Information Technologies Basics, Web design and programming, Internet programming
- Database programming department: Information Technologies Basics, Visual programming, Object-oriented programming

The important point is that, the modular structure of the new IT curriculum provides flexibility; therefore schools are responsible to adapt the framework IT program according to their conditions in collaboration with IT industry. The first consideration is the needs of local IT sector and community. Vocational high schools should respond the local needs besides the global and national ones. Individual students' needs and characteristics are another concern that should be taken into account in curriculum adaptation. In order to enhance the implementation feasibility of adapted program, schools infrastructure circumstances should also be evaluated. The minimum standards for the required laboratories and equipments are specified in the occupational standards as well.

2.6. Research Studies on Vocational Program Evaluation

In this section, some research studies on vocational program evaluation have been reviewed. Horng (2004), analyzed developmental trends, hospitality curricula structures and strategies of curriculum development for planning the integrated curriculum of foods and beverage (F&B) management of the vocational and technological educational system in Taiwan with using the qualitative and quantitative research methods. According to the results of this study, the cooperation between schools and industries has to be advanced. Therefore, in curriculum development theory and practice should be combined and experience opportunities in workplace should to be improved. With a competency-based framework hospitality education will be more flexible in a way that is more adaptable to individual needs and international accreditation system. Moreover it is concluded that by fully utilizing teaching resources curriculum design will be more adaptable to horizontal and vertical connections. In summary, the major findings of the research provide a basis for curriculum development of F&B management education (Horng, 2004).

Salah (2002), performed a study to evaluate vocational curriculum of Department

of Production Engineering at College of Technological Studies (CTS) in Kuwait. The study is based on extensive fieldwork that encompassed a review of related literature, questionnaires and personal interviews with the dean of the CTS, and selected staff and students. The importance of this reviewing effort is to identify the links between the CTS and local industry, examine the perceptions of staff towards the quality of the curriculum and perceptions of industrialists in relation to the standards of CTS graduates in order to upgrade program to meet the local market requirements. The results of the study show that the linkage between CTS and industry is very limited. CTS graduates are forced to enrol to continue in-service training programs to reach the expected standards. The CTS program does not supply the skilled manpower demands of industry. Thus, The CTS programme should be revised in a way that takes into market requirements (Salah, 2002).

In her thesis McAlister (2006), investigated faculty and graduates perceptions of vocational evaluation competencies in curriculum. The study surveyed 55 faculty and practitioners in regards to 51 competencies. Differences in means were compared between the following groups: vocational evaluation faculty, vocational evaluation graduates, rehabilitation counselling graduates with a specialty in vocational evaluation, rehabilitation counselling graduates, and other unspecified graduates. These findings suggest that a difference exists between curricula in terms of obtaining vocational evaluation competencies at the university level, and between the two professions of rehabilitation counselling and vocational evaluation. Significant differences were found between the faculty members and other unspecified graduates for the competencies of job analysis and vocational interviewing skills. In addition, the competency of awareness/inclusion of cultural diversity received a lower rating by vocational evaluation graduates as compared to the ratings of rehabilitation counselling graduates and faculty (McAlister, 2006).

Dirkx (1999), evaluated Michigan Department of Corrections (MDOC) vocational programs in terms of their overall purposes, intent, similarities, differences, and relevance to labour market trends and employability. The mission of the these programs is to offer incarcerated individuals an opportunity to gain academic, social, and work skills to become productive citizens while in prison and when released to the community. Data were collected through In-depth interviews

conducted with facility, regional and central office administrators, vocational teachers, and potential employers; observations; and document analysis in 15 different facilities.

According to the results of this study current policies negatively affect vocational programming, in terms of inmate participation, completion of programs, updating technology, materials, and resources, and determining program outcomes. The partnerships with employer groups and educational agencies external to MDOC are insufficient; therefore there are problems related to communication, cooperation, and currency and standardization of curricula. Finally, few programs have on-going continuous program improvement processes in place or procedures for obtaining information on their students once they leave the prison system. Consequently, vocational programs experience relatively low completion rates because of a variety of reasons (Dirkx, Kielbaso, & Corley, 1999).

Olkun (1995), performed a qualitative research to assess students' transition to real life work environment through a case study in Balgat industrial vocational and technical high school. Data gathered via interviews with graduates and employers (Olkun, 1995). Şirin (2005) conducted a similar research to evaluate modular programs applied in vocational high school within the scope of METGE project. She examined the perspectives of teachers and students by the use of quantitative methods (Şirin, 2005).

CHAPTER 3

METHOD

The model of the curriculum evaluation, the overall design of the study, the research questions, research population and sampling, the data collection instruments and the methods of data analyze are explained in this chapter.

3.1. Overall Research Design

The aim of this study is to conduct a formative evaluation based on CIPP (Context, Input, Process, Product) Model-Process Evaluation by Stufflebeam (1971) in which the main purpose is provide feedback in relation to needed modifications on new vocational high schools IT curriculum if the implementation is inadequate and making a comparison of actual implementation with the intended program (Gredler, 1996).

There are various models and approaches for curriculum evaluation. However, CIPP model is the one of the most widely used model in vocational curriculum evaluation as described in the literature part. In our case process evaluation is the most fitting mode of CIPP model, due to its direct focus on operation of curriculum. Process evaluation can be used to examine whether an innovative program is operating properly, thus outcomes of this evaluation will be valuable for curriculum improvement (Finch & Crunkilton, 1989).

The progress of this evaluation work can be described with Illuminative Model stated by Parlett and Hamilton (1972), from the very beginning to the end CIPP process evaluation. The illuminative evaluation model makes ample use of informal, observational means of collecting data and is perhaps the best known example of the non-conventional approaches to evaluation that emerged in the 1970s. Illuminative Model is called as non-conventional because it focus on how the curriculum actually worked in action, rather than on its objectives only. And

the efficiency of an modernization was evaluated in terms of whether it had reached required standards on pre-determined criteria. Furthermore this model supports conclusions of evaluation to all participants in the curriculum, not only to remote decision makers (March & Willis, 1999).

The overall design of this evaluation work summarized in Figure 20 in line with the stages of Illuminative Model. Accordingly, the evaluation started with the observations of the complex learning milieu. The learning milieu represents a complicated pattern of interactions between teachers and students. Illuminative Model stressed that each educational situation and context is unique and a curriculum is never implemented exactly as planned. Thus the evaluator should investigate the learning milieu to comprehend the reality of curriculum. In order to remark the significant features of ongoing events of new IT curriculum, we are observing pattern of interactions in schools and interviewing informally with school personnel, students and SVET project staff since the implementation began with the 2004-2005 academic year.

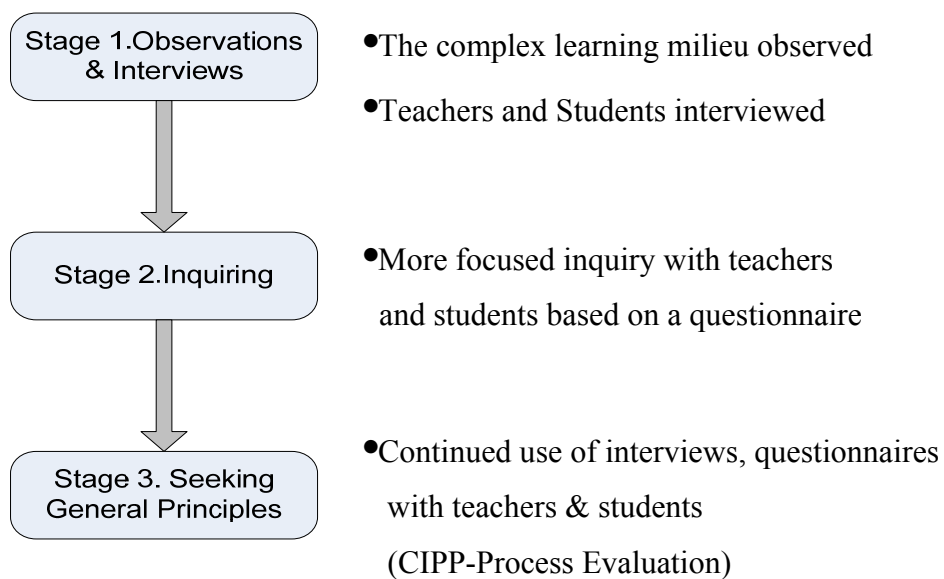

Figure 20. Overall Design of the Study

Next, in the stage 2 the evaluation continued with the more focused inquiry by teachers and students based on a questionnaire in the case of Çankaya

Cumhuriyet Trade Vocational High School during the second year of new IT curriculum implementation. The aim of this inquiry was to derive specific information about the attitudes and opinions of teachers and students on impacts of new IT curriculum. The main curricular considerations were flexibility, lifelong learning, responsiveness of local and global needs and required infrastructure.

The last and the main part of this evaluation work is stage 3 “seeking general principles”. In the light of previous observations and inquiries, the formative evaluation performed based on CIPP process evaluation. The aim of this part is determining how well the curriculum is working out in practice and placing restricted findings within a broader clarifying context.

3.2. Research Questions

The specific research questions used in the study were:

1. To what extent are the objectives and content of Vocational high schools’ new IT curriculum fulfilled the needs of IT labour market?
 - a. Does the Vocational high school new IT curriculum meet the needs of global IT sector?
 - b. Does the Vocational high school new IT curriculum meet the needs of national IT sector?
 - c. Does the Vocational high school new IT curriculum meet the needs of local IT sector and community?

2. To what extent is the flexibility actualized in execution of Vocational high schools’ new IT curriculum?
 - a. Does the Vocational high school new IT curriculum supply program flexibility?
 - b. Does the Vocational high school new IT curriculum supply individual flexibility?
 - c. Does the Vocational high school new IT curriculum supply presentation flexibility?

- d. Does the Vocational high school new IT curriculum supply educational route flexibility?
3. To what extent are the educational settings suitable for to be implementation of the Vocational high schools new IT curriculum in the way it is intended?
- a. Do the students have proposed abilities for learning with new IT curriculum?
 - b. Do the teachers have proposed abilities for teaching with new IT curriculum?
 - c. Are the school quality indicators inline with the needs of new IT curriculum?
 - d. Do the modules of the new IT curriculum meet the needs of students and teachers?

3.3. Population

In our new decentralized vocational education system, school personnel should collaborate with social partners for analyzing the needs of school district's community and labour market so as to adapt and arrange the instruction based on local demands. After specification of regional competencies for a specific occupational profile, teachers and school administrators are responsible for comparing them with the training standards of job, which were determined in the framework program of Ministry of National Education (MoNE). As a result of this comparison they select organize the courses and modules into the grades according to the prerequisite and advance conditions in way to cover common core competencies. In this organization process school personnel also should analyze the initial starting situation of students, teachers and infrastructure etc. and these elements should be taken into account in instructional design. Therefore teachers are the ones shaping and interpreting the global and local occupational standards and translating the curriculum intentions into classroom practices so that they can provide constructive and effective information about the implementation process

for the new Information Technologies Curriculum of Vocational High Schools.

Table 2. *Subjects of the Study (district)*

SUBJECTS OF THE STUDY			
QUANTITY OF SUBJECTS		Students	Teachers
	Altındağ	130	23
	% in subjects	19	27.7
	Çankaya	189	23
	% in subjects	27.7	27.7
	Etimesgut	6	1
	% in subjects	0.9	1.2
	Keçiören	97	10
	% in subjects	14.2	12
	Mamak	97	10
	% in subjects	14.2	12
	Sincan	69	7
	% in subjects	10.1	8.4
	Yenimahalle	95	9
	% in subjects	13.9	10.8
	Total	683	83

All Information Technologies teachers and 11th grade students in vocational high schools in Turkey will be defined as target population of this study. Since it is very difficult to cope with target population, accessible population should be defined. The accessible population of this study is all Information Technologies teachers and 11th grade students in vocational high schools in metropolitan of Ankara.

There are seven urban districts in metropolitan of Ankara. These are Altındağ, Çankaya, Etimesgut, Keçiören, Mamak, Sincan and Yenimahalle.

The required information such as list of the schools, number of IT teachers, and students in each school were received from the MoNE statistical department.

The subjects of the study: the number of IT teachers and 11th grade IT area students summarized in Table 2 based on the district of the school and in **Table 3** based on the DGs they linked. Accordingly, 683 11th grade students and 83 IT teachers were voluntary to participate the study from 28 different vocational high schools.

Table 3. Subjects of the Study (district)

SUBJECTS OF THE STUDY			
QUANTITY OF SUBJECTS		Students	Teachers
	DG of Commerce and Tourism Education	138	26
	% in subjects	20.2	31.3
	DG of Technical Education for Boys	308	37
	% in subjects	45.1	44.6
	DG of Technical Education for Girls	237	20
	% in subjects	34.7	24.1
	Total	683	83

3.4. Data Analysis and Instruments

In this study quantitative techniques were used in analyzing the data collected through questionnaires. Percentages, means and standard deviations were calculated for descriptive statistics and two-way contingency table analysis were calculated for inferential statistics with using the SPSS (Statistical Packages for Social Sciences) program.

Two types of survey questionnaire were used in the study to obtain information on the implementation of newly adopted vocational high schools' Information Technologies curriculum and determine if it is progress appropriate to its fundamentals. The first questionnaire is for IT teachers, titled "Evaluation Questionnaire of Vocational High Schools' Information Technology Area Curriculum for teachers" (see Appendix J). The second questionnaire is for IT area 11th grade students, titled "Evaluation Questionnaire of Vocational High Schools' Information Technology Area Curriculum for students" (see Appendix K). These questionnaires were developed by the researcher based on the essentials of competency based modular IT curriculum originated from related literature in chapter 2.

3.4.1. Teachers' Questionnaire

Evaluation Questionnaire of Vocational High Schools' Information Technology Area Curriculum for teachers was initiated with a cover letter that explains the

purpose and the importance of the research for motivating the subjects. It was comprised of three main parts. The first part includes 14 questions related to teachers' demographic characteristics and general information on their school. The second part is the core part of the questionnaire and consists of 63 questions on seven different sub-topics: Teachers, aims of area and departments, content, teaching-learning process, infrastructure conditions, modules and students. Firstly the intent of this part is to detect teachers' perceptions on the objectives of IT area and its four departments and the related learning content as well. Next, the instructional processes assessed to investigate whether the implementation is appropriate to the basics of modular competency-based context. And the infrastructure conditions and modules are scanned if they are adequate to support the new IT curriculum from the views of teachers. Furthermore teachers evaluated students and themselves on the adaptability of new curriculum. The last part of the questionnaire tries to investigate whether the teachers using proper teaching methods and approaches and assessment and measurement techniques during instruction. The last topic of this part is detecting the obstacles that teachers faced during implementation of new IT curriculum.

3.4.2. Students' Questionnaire

Evaluation Questionnaire of Vocational High Schools' Information Technology Area Curriculum for students consists of two main parts. The first part directed 4 questions to students on demographical information. And the second part includes 23 questions in order to recognize the students' thoughts about the implementation of new IT curriculum. In this part, the intention is investigating whether the students learning in consistent with modular curriculum principles.

The questionnaires were constituted of closed ended questions with the intention of enhancing consistency in responses across subjects and easiness of tabulation. The subjects of the study were asked to rate most of the statements based on a five-level Likert type scale: Strongly agree, Agree, Neither agree nor disagree, Disagree and Strongly disagree. And in some parts they rated on a scale of: Always, Often, Sometimes, Rarely and Never. The participants indicated their choice by circling the item that corresponded with their perception.

3.4.3. Validity and Reliability of Instruments

The items of questionnaire were assessed by four experts in the field of ‘Curriculum and Instruction’ and ‘Information Technology Education’ after ensuring the connection between questionnaire items and objectives of the study. These experts were well informed about the basics of new competency based modular IT curriculum hence they judged if the items of questionnaire were matching with the curriculum basics. This valuable evaluation will be used for checking the content validity of the instrument. In addition to the conceptual verification of the questions, a Turkish teacher examined the questionnaire items for determining inadequately worded questions.

Next, after performing required revisions in the light of expert opinions the questionnaires were pilot tested in Çankaya Cumhuriyet Trade Vocational High School. Five IT teachers and twenty 11th grade IT area students were evaluated questionnaires whether the items were easily comprehensible in terms of their language, clarity of directions etc and if they were needed modifications for enhancing the validity of the instruments.

Afterwards, short interviews were performed with teachers and students on major issues of new IT curriculum for examining the reliability of the questionnaires. The teachers and students responses to interview questions were compared with the responses of the questionnaires items to see if there was a consistency between two instruments. Furthermore two internal consistency estimates of reliability were computed for students and teachers questionnaires. The coefficient alpha value for the Evaluation Questionnaire of Vocational High Schools’ Information Technology Area Curriculum for teachers was .96 and for the Evaluation Questionnaire of Vocational High Schools’ Information Technology Area Curriculum for students was .85. These values suggest that the scale scores indicating satisfactory reliability.

3.5. Limitations of the Study

If the external validity issue considered for population generalizability, the results of this research will be generalized to its accessible population: all Information Technologies teachers and IT area students in vocational high schools in Ankara.

And to its target population: all Information Technologies teachers and IT area students in vocational high schools in Turkey. Anyway it would be better to perform this research in a countrywide context to picture the implementation differences among regions and cities with the support of MoNe.

The research was executed in three types of vocational high schools resulting from maximum variation sampling. However there are also small differences within these main categories such as: Anatolian vocational high schools, Technical vocational high schools and Anatolian technical high schools. And it is almost impossible to consider the minor framework program's differences of these all types of vocational high schools. Hence the research were performed regarding a common framework program, however research results will be generalized to all types of vocational high schools. Moreover, this research were carried out in urban school district and research results will be generalized all vocational high schools in Turkey including urban, suburban or rural school environments.

Possible extraneous variables of this study were: age and gender of teachers, the personality and world view of teachers, time of the day for data collection, days of the week for data collection, the location of the school and the socio economic conditions of community in the district. Hence in order to enhance generalization, relevant characteristic of the subjects that may affect the results were obtained and taken into account in data analysis.

CHAPTER 4

RESULTS

The results of this study will be examined under the sections 4.2, 4.3 and 4.4 and related sub-sections inline with the three main research questions stated in the methodology part. Demographic information of respondent teachers and students will be summarized before illustrating the findings in order to enlighten the results. Furthermore Implementation problems faced by the teachers during instruction will be discussed at the end of this part of study.

4.1. Demographic Information of Subjects

Firstly, if the return rates of questionnaires considered, 803 students questionnaires and 138 teachers' questionnaires were distributed through 33 vocational high schools during the second term of 2007-2008 academic year in 7 selected district in Ankara. 683 students and 83 teachers were voluntary to participate the study from 28 vocational high schools. The overall return rates were 85.05 % for student questionnaires and 60.14 % for teacher questionnaires.

The related demographic information of 683 students answering the questionnaires is presented briefly in **Table 4**. The greater parts of the respondent students were males (57.4 %) and most of them were attending to Anatolian vocational high schools (49.3 %) considering the type of the school. 45.1 % of the students were attending vocational high schools linked to DG of Technical Education for Boys. DG of Technical Education for Girls follows it with the proportion 34.7 %.

The Çankaya district was formed the main part in the respondent students with the number of 189 (27.7 %) and Altındağ district was formed the second largest part with the number of 130 (19.0 %). However Etimesgut district's representation was slight with the proportion .9 since there is only one school with an IT department in that district.

Additionally, Web programming branch of Information Technologies area (65.4 %) constitutes major part, on the other hand Network Management of Information Technologies area (6.1 %) constitutes the minor part in the distribution of respondent students among four branches of IT area.

Table 4. *Demographic Distributions of Students*

Variables		<i>f</i>	<i>p</i>
Sex	Female	291	42.6
	Male	392	57.4
		N=683	
Type of the School	Anatolian Technical High School	102	14.9
	Technical High School	46	6.7
	Anatolian Vocational High School	337	49.3
	Vocational High School	198	29.0
		N=683	
Type of the Branch	Computer Technical Service	34	5.0
	Database Programming	160	23.4
	Web programming	447	65.4
	Network Management	42	6.1
		N=683	
General Directorate of School	DG of Commerce and Tourism Education	138	20.2
	DG of Technical Education for Boys	308	45.1
	DG of Technical Education for Girls	237	34.7
		n=683	
Name of the School District	Altındağ	130	19.0
	Çankaya	189	27.7
	Etimesgut	6	.9
	Keçiören	97	14.2
	Mamak	97	14.2
	Sincan	69	10.1
	Yenimahalle	95	13.9
		n=683	

The related demographic information of 83 IT teachers answering the questionnaires is presented briefly in **Table 5**. Accordingly, the numbers of the

male and female respondent teachers in the sample were approximately close to each other. 42 (50.6 %) of them were females and 41 (49.4 %) of them were males. The greatest part of the teachers had the teaching experience between 11-15 years (37.3 %). Between 6 and 10 years of experience follows it with the number of 28 (33.7 %) teachers. Only ten of them had the teaching experience above 15 years.

Table 5 .*Demographic Distributions of Teachers*

Variables		<i>f</i>	<i>p</i>
Sex	Female	42	50.6
	Male	41	49.4
		N=83	
Year of Experience	1-5	14	16.9
	6-10	28	33.7
	11-15	31	37.3
	16-20	5	6.0
	21-24	4	4.8
	25 and above	1	1.2
		n=83	
General Directorate of School	DG of Commerce and Tourism Education	26	31.3
	DG of Technical Education for Boys	37	44.6
	DG of Technical Education for Girls	20	24.1
		n=83	
Name of the School District	Altındağ	23	27.7
	Çankaya	23	27.7
	Etimesgut	1	1.2
	Keçiören	10	12.0
	Mamak	10	12.0
	Sincan	7	8.4
	Yenimahalle	9	10.8
		n=83	
Teacher Status	Expert Permanent	20	24.1
	Permanent	62	74.7
	Contract Personnel	1	1.2
		n=83	

Moreover, near to all of the respondent teachers were permanent considering the working status in MoNE and 24.1 % of them are expert teachers. The major part of

the teachers was working in the vocational high school linked to DG of Technical Education for Boys (44.6 %). However the proportion of the teachers working linked to the DG of Technical Education for Girls had the minor representation in the sample (24.1 %). Altındağ and Çankaya were the district that more than half of the teachers were working in vocational high schools there. Totally 55.4 % of teachers were from these districts. On the other hand Etimesgut is the less represented district with the proportion of 1.2 % in the sample.

4.2. The objectives and content of IT curriculum in relation to labour market

The research question related to this part of result is:

- To what extent are the objectives and content of Vocational high schools' new IT curriculum fulfilled the needs of IT labour market?

This research question will be investigated in the following parts with predicating on the perceptions of teachers.

4.2.1. Global IT sector

The sub-question related to this part is:

- Does the Vocational high school new IT curriculum meet the needs of global IT sector?

In order to examine this sub-question data were gathered through The Evaluation Questionnaire of Vocational High Schools' Information Technology Area Curriculum for teachers applied to the IT teachers.

The main rationale of change in the vocational high school curricula and the structure was to provide high-quality vocational education that meets the needs of industry. The first level of concern is coming across with the world standards in vocational education as well as the European standards. Hence with this research question, the intent is determining if the IT curriculum fulfils catching up global needs of labour market from the viewpoints of IT teachers.

The related six items of teachers' questionnaire were examined with the intention of illuminating the topic and the frequency distribution of respondent results are

shown in **Table 6**.

The first two questions are to inquiry teachers' beliefs on new IT program objectives whether they are matching with the innovations of IT global sector or they include needed core skills of occupational profiles of IT area. Then teachers are demanded to assess if the program content is sufficient to react the global skill requirements of IT sector.

Table 6. *Frequency distribution of teachers on global IT sector*

Items		<i>f</i>	<i>p</i>
1.The objectives of the program are parallel to the innovations of IT global sector	Strongly disagree	1	1.2
	Disagree	5	6.0
	Neither agree nor disagree	13	15.7
	Agree	52	62.7
	Strongly agree	12	14.5
	n=83		
2.The objectives of the program precisely cover the needed skills of IT occupations	Strongly disagree	1	3.6
	Disagree	5	14.5
	Neither agree nor disagree	13	24.1
	Agree	52	50.6
	Strongly agree	12	7.2
	n=83		
3.The content is adequate to actualize the objectives of the program	Strongly disagree	7	8.4
	Disagree	16	19.3
	Neither agree nor disagree	19	22.9
	Agree	36	43.4
	Strongly agree	5	6.0
	n=83		
4.10th grade course content is sufficient in achieving basic skills of IT area	Strongly disagree	6	7.2
	Disagree	16	19.3
	Neither agree nor disagree	21	25.3
	Agree	33	39.8
	Strongly agree	7	8.4
	n=83		
5.11th and 12th grade course content is sufficient in achieving specific skills of IT departments	Strongly disagree	9	10.8
	Disagree	11	13.3
	Neither agree nor disagree	24	28.9
	Agree	33	39.8
	Strongly agree	6	7.2
	n=83		

6.The content of courses	Strongly disagree	5	6.0
related to generic skills such	Disagree	22	26.5
as adaptability to work	Neither agree nor disagree	28	33.7
environment, good	Agree	21	25.3
communication etc. is	Strongly agree	7	8.4
satisfactory		n=83	

Among 83 IT teachers included in the study, more than half of them agreed or strongly agreed that the objectives of the program are parallel to the innovations of IT global sector with the mean of 3.83 (SD=.794). The number of agreed teachers is 52 (62.7 %) and the number of moderately agreed teachers is 12 (14.5%). Whereas, 6 (7.2 %) of them disagreed or strongly disagreed on this item. The frequency distribution is represented in *Figure 21* below.

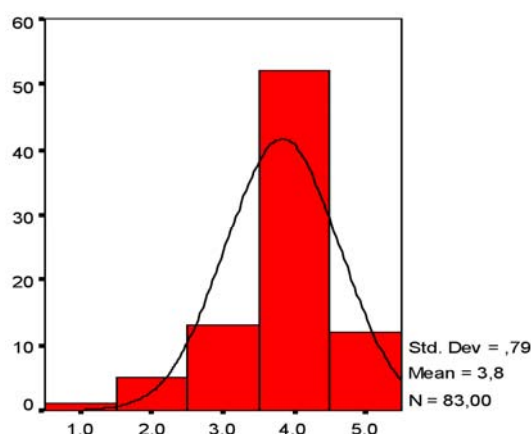

Figure 21. Frequency of item 1

As can be seen from Table 6, nearly half of the teachers have the same opinion that the objectives of the program precisely cover the needed skills of IT occupations. 42 (50.6 %) of them agreed, and 6 (7.2 %) of them strongly agreed with the item. However the significant amount of the respondent teachers do not have certain decision on the topic with the proportion 24.1% and 15 (18,1 %) of them disagreed that the objectives of the program covers the needed skills exactly

If the content of the IT program considered, 36 (43.4 %) of the teachers agreed and 5 (6 %) of the teachers strongly agreed that the content is adequate to actualize

the objectives of the program. On the other hand, 19 of the teachers did not have definite opinions on the topic. And 21 (27.7 %) of them disagree or strongly disagree that the program content is sufficient to achieve the objectives.

According to the descriptive statistics represented in Table 7, nearly half of the IT teachers agreed that the objectives of the program precisely cover the needed skills of IT occupations with the mean of 3.43 (SD=.952). Moreover, nearly half of the IT teachers agreed that the content is adequate to actualize the objectives of the program of with the mean of 3.19 (SD=1.029).

Table 7. Descriptive statistics of item 1, 2 and 3

<i>Items</i>	<i>M</i>	<i>Median</i>	<i>Mode</i>	<i>SD</i>
1.The objectives of the program are parallel to the innovations of IT global sector	3.83	4.00	4	.794
2.The objectives of the program precisely cover the needed skills of IT occupations	3.43	4.00	4	.952
3.The content is adequate to actualize the objectives of the program	3.19	3.00	4	1.087

As illustrated in Table 6, the investigation deepened the details of content with the Questionnaire items 4,5 and 6. Accordingly, if the teachers are asked to assess 10th grade course content, 33 (39.8 %) of them agreed and 7 (8.4 %)of them strongly agreed that it is sufficient in achieving basic skills of IT area with the mean of 3.23 (SD=1.086). However, 21 (25.3 %) of the respondents did not have a clear opinion on the topic and 22 (26.5 %) of them strongly disagreed or disagreed that the 10th grade course content is sufficient in achieving basic skills of IT area.

The results of investigation item 5 proved the similar results that, 39 (47 %) out of 83 teachers strongly agreed or agreed that the 11th and 12th grade course content is sufficient in achieving specific skills of IT departments with the mean of 3.19 (SD=1.109). However, 24 (28.9 %) of teachers did not have clear opinion and 20 (24.1 %) of them were in disagreement on the topic. Furthermore, teachers as

well assessed if the content of courses related to generic skills such as adaptability to work environment, good communication etc. is satisfactory. Significantly more than half of them were uncertain or disagreed that the content of courses related to generic skills is satisfactory. Only 28 (33.7 %) of the teachers agreed or strongly agreed on the item with the mean of 3.04 (SD=1.053).

Table 8. *Descriptive statistics of item 4, 5 and 6*

<i>Items</i>	<i>M</i>	<i>Median</i>	<i>Mode</i>	<i>SD</i>
4.10th grade course content is sufficient in achieving basic skills of IT area	3.23	3.00	4	1.086
5.11th and 12th grade course content is sufficient in achieving specific skills of IT departments	3.19	3.00	4	1.109
6.The content of courses related to generic skills such as adaptability to work environment, good communication etc. is satisfactory	3.04	3.00	3	1.053

Two-way contingency table analyses were conducted to evaluate whether the teachers' perspective on common content differ up to the general directorate their school linked. The two variables were general directorate of the school with three categories (DG of Commerce and Tourism Education, DG of Technical Education for Boys and DG of Technical Education for Girls) and teachers' perspective with three levels (Strongly disagree & Disagree, Neither agree nor disagree, Agree & Strongly agree). Teachers' perspective on the item of "11th and 12th grade course content is sufficient in achieving specific skills of IT departments" and the general directorate of their school were found to be significantly related, Pearson X^2 (4, n=83)=11.7, p=.02, Cramer's V=.27. The given proportions according to **Table 9**, the agreed and strongly agreed teachers from the schools linked to DG of Technical Education for Boys more than the schools linked to DG of Technical Education for Girls and DG of Commerce and Tourism Education: .60, .45 and .31 respectively. Most of the teachers from the vocational high schools linked to DG

of Technical Education for Girls and DG of Commerce and Tourism Education strongly disagree or disagree that the 11th and 12th grade course content is sufficient.

Table 9. *Teachers' perspectives on content by General Directorate of the School*

General Directorate of the School			
11th and 12th grade course content is sufficient in achieving specific skills of IT departments, X^2 (df=4, n=83)=11.7, p=.02			
	Strongly disagree & disagree	Neither agree nor disagree	Strongly agree & agree
	n=20 %	n=24 %	n=39 %
DG of Commerce and Tourism Education	34.6	34.6	30.8
DG of Technical Education for Boys	8.1	32.4	59.5
DG of Technical Education for Girls	40	15	45

Summary

In relation to the needs of global IT sector, most of the teachers were of the same mind that the objectives of the new IT program are inline with the new developments in global IT sector and these objectives include the needed skills in the world of work. Moreover, they also commented that the content of the program is sufficient enough to reach the defined objectives considering the whole system and grades separately as well. Nevertheless, most of the teachers were not sure or dissent that the content covers satisfactory generic skills required in work environment.

On the other hand, there is a significant difference between the teachers' perspectives on sufficiency of the 11th and 12th grade course content, which constitutes the departmental programs. Teachers from the vocational high schools linked to DG of Technical Education for Boys more agreed on the topic.

4.2.2. National IT sector

The sub-question related to this part is:

- Does the Vocational high school new IT curriculum meet the needs of national IT sector?

In order to examine this sub-question data were gathered through The Evaluation Questionnaire of Vocational High Schools' Information Technology Area Curriculum for teachers applied to the IT teachers in vocational high schools.

As stated before, primarily our country attempt to reach the world industry standards with the new competency based modular vocational high school curricula. Providing standards within the country, on the other hand, is also another significant purpose. Hence, with this research question the intention is determining if the IT curriculum fulfil to catching up national needs of labour market from the viewpoints of IT teachers.

The related two items of teachers' questionnaire were examined with the intention of illuminating the topic and the frequency distribution of respondent results are shown in Table 10. The first item is for investigating whether the objectives of the IT program matching up with the national interests and expectations of the sector. The next, requires teachers to assess four departments of IT area if they are matching with the national IT sector necessitates.

Among 83 IT teachers included in the study, significantly more than half of them were of the same opinion that the objectives of the program meets the needs of IT national sector with the mean of 3.72 (SD=.888). The number of agreed respondents is 46 (55.4 %) and the number of strongly agreed respondents 12 (14.5 %). However, 17 (20.5 %) of them were not certain on the item. The rest 8 (7.2 %) of the respondents strongly disagreed or disagreed that the objectives of the program meets the needs of IT national sector. The frequency distribution is shown in **Figure 22**.

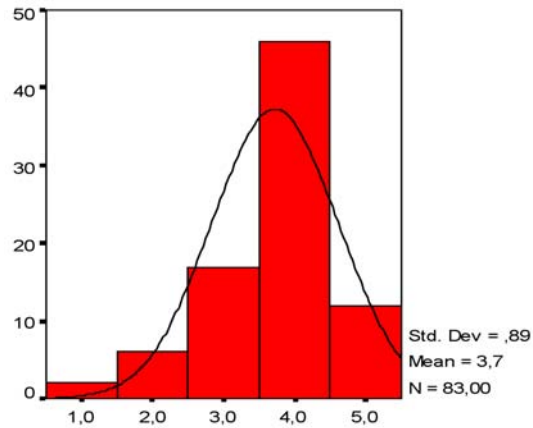

Figure 22. Frequency of item 1

Next, significantly more than half of the teachers were of the same opinion that the departments are inline with the national occupational profiles of IT area. 48 (57.8 %) of them agreed and 8 (9.6 %) of them strongly agreed on the item with the mean of 3.65 (SD=.862). However, 20 (24.1 %) of the respondents uncertain and the rest disagreed that the departments are inline with the national occupational profiles of IT area.

Table 10. *Descriptive statistics of teachers on national IT sector*

Items		<i>f</i>	<i>p</i>	<i>M</i>	<i>SD</i>
1.The objectives of the program meets the needs of IT national sector	Strongly disagree	2	2.4	3.72	.888
	Disagree	6	7.2		
	Neither agree nor disagree	17	20.5		
	Agree	46	55.4		
	Strongly agree	12	14.5		
		n=83			
2.The departments are inline with the national occupational profiles of IT area	Strongly disagree	3	3.6	3.65	.862
	Disagree	4	4.8		
	Neither agree nor disagree	20	24.1		
	Agree	48	57.8		
	Strongly agree	8	9.6		
		n=83			

Summary

In relation to the needs of national IT sector, most of the teachers were of the same mind that the objectives of the new program meets the national needs of sector and four departments of new IT program supports the required occupational profiles of IT national sector.

4.2.3. Local IT sector and community

The sub-question related to this part is:

- Does the Vocational high school new IT curriculum meet the needs of local IT sector and community?

In order to examine this sub-question data were gathered through The Evaluation Questionnaire of Vocational High Schools' Information Technology Area Curriculum for teachers applied to the IT teachers in vocational high schools.

One of the most essential innovations of the new IT program is its decentralized nature. The new program aims to adapt the framework IT program up to the local labour market and community requirements. Appropriately, the main intention is constructing a vocational education system, which is more responsive to global, national, and local needs. Therefore, with this research question the intent is determining if the IT curriculum fulfils to catching up local needs of labour market and community from the viewpoints of IT teachers.

In this part of results, the related three items of teachers' questionnaire were examined with the target of initializing the topic and in the following parts, the local adaptability of the program was investigated in detail. In Table 11, the related items of questionnaire are listed and frequency distributions of respondent results are shown.

Among 83 IT teachers included in the study, 45 (54, 2 %) of them agreed or strongly agreed that the objectives of the program are responsive to the local industry needs with the mean of 3.46 (SD=.831). On the other hand, an important number of the respondents were not confident with the proportion 36.1% and the others (9,6 %) disagreed or strongly disagreed through the idea.

Table 11. *Descriptive statistics of teachers on local IT sector*

Items		<i>f</i>	<i>p</i>	<i>M</i>	<i>SD</i>
1.The objectives of the program are responsive to the local industry needs	Strongly disagree	3	3.6	3.46	.831
	Disagree	5	6.0		
	Neither agree nor disagree	30	36.1		
	Agree	41	49.4		
	Strongly agree	4	4.8		
		n=83			
2.The objectives of the program are responsive to the requirements and expectations of local community	Strongly disagree	4	4.8	3.49	.875
	Disagree	5	6.8		
	Neither agree nor disagree	24	28.9		
	Agree	46	55.4		
	Strongly agree	4	4.8		
		n=83			
3.The content is comprised of occupational skills that my school claims	Strongly disagree	5	6.0	3.17	.935
	Disagree	12	14.5		
	Neither agree nor disagree	33	39.8		
	Agree	30	36.1		
	Strongly agree	3	3.6		
		n=83			

Furthermore, 50 (60,2 %) of the IT teachers agreed or strongly agreed that the objectives of the program are responsive to the requirements and expectations of local community with the mean of 3.49 (SD=.875). However, 33 (39,8 %) of the respondents did not have a certain idea or disagreed on the item. The frequency distributions are illustrated in **Figure 23** and **Figure 24**.

The new IT framework program is common for all types of vocational high schools. Actually, in the old one schools were implementing different IT programs based on the purpose of their linked DG (DG of Technical Education for Boys, DG of Technical Education for Girls, DG of Commerce and Tourism Education). With item 3, teachers were required to assess whether the content of IT program comprised of occupational skills that their school claims. According to the results represented in Table 11, 33 out of 83 IT teachers did not have a certain idea and 17 of them disagreed on the topic with an important proportion of 60.3 %. On the other hand, the rest of them (39.7 %) reached in agreement on the item with the

mean of 3.17 (SD=.935).

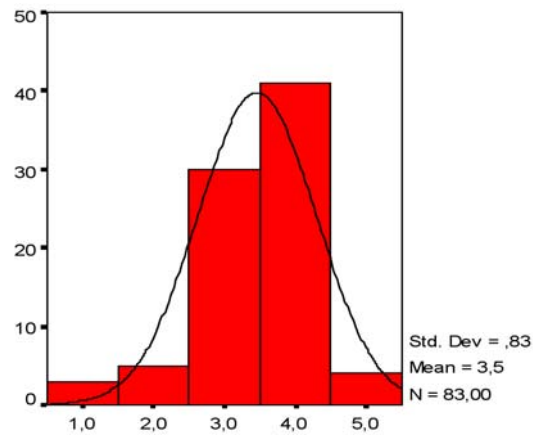

Figure 23. Frequency of item 1

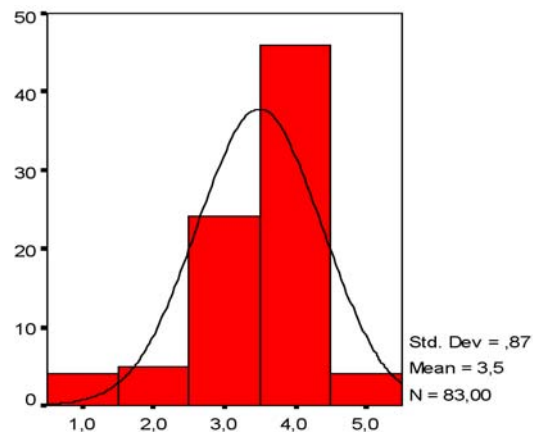

Figure 24. Frequency of item 2

Furthermore, a two-way contingency table analysis was conducted to evaluate whether the teachers' perspective differ up to the general directorate of their school linked on the item 3. The two variables were general directorate of the school with three categories (DG of Commerce and Tourism Education, DG of Technical Education for Boys and DG of Technical Education for Girls) and teachers' perspective with three levels (Strongly disagree & Disagree, Neither agree nor disagree, Agree & Strongly agree). Teachers' perspective and the general directorate of their school were found to be significantly related, Pearson

$X^2(4, n=83)=13.02, p=.01$, Cramer's $V=.28$. According to the given proportions in **Table 12**, the agreed and strongly agreed teachers from the schools linked to DG of Technical Education for Boys were more than the schools linked to DG of Technical Education for Girls and DG of Commerce and Tourism Education: .43, .40 and .35 respectively.

Table 12. *Teachers' perspectives by General Directorate of the School*

General Directorate of the School			
The content is comprised of occupational skills that my school claims, $X^2(df=4, n=83)=13.02, p=.01$			
	Strongly disagree & disagree	Neither agree nor disagree	Strongly agree & agree
	n=17 %	n=33 %	n=33 %
DG of Commerce and Tourism Education	19.2	46.2	34.6
DG of Technical Education for Boys	8.1	48.6	43.2
DG of Technical Education for Girls	45.0	15.0	40.0

Summary

In relation to the needs of local IT sector, most of the teachers were of the same mind that the objectives of the new IT program meet the needs of local IT sector and local community as well.

However, less than half of them concurred that the common content of the new program serves the purposes of their school. As the purpose of the schools depends on the general directorate that they linked and according to the results the content is more responsive to the schools linked to DG of Technical Education for Boys. Teachers commented that the new IT program committee was comprised of teachers from the vocational high schools linked to DG of Technical Education for Boys hence the new IT program mostly serves the purposes of these schools.

Especially, the teachers from the vocational high schools linked to DG of Commerce and Tourism Education remarked that although the content of the new IT program is meets the needs of local labour market, it includes more technical courses comparing with the old one. Thus, it is not exactly adequate to their schools' and more fitting to the vocational high schools linked to DG of Technical Education for Boys.

4.3. Flexibility of IT curriculum

The research question related to this part of result is:

- To what extent is the flexibility (program adaptation) actualized in execution of Vocational high schools' new IT curriculum?

This research question will be investigated in the following parts with predicating on the perceptions of teachers and students.

4.3.1. Program Flexibility

The sub-question related to this part is:

- Does the Vocational high school new IT curriculum supply program flexibility?

In order to examine this sub-question data were gathered through The Evaluation Questionnaire of Vocational High Schools' Information Technology Area Curriculum for teachers applied to the IT teachers in vocational high schools.

One of the imperative innovations of new vocational high school's curricula is its modularized structure to support flexibility. The function of flexibility in programs is providing easily adaptability to the rapidly changing skill demands of industry and technology. Therefore, flexibility results in strengthening the linkage between vocational schools and industry. This research question proposes to determine if the IT curriculum supplies program flexibility from the viewpoints of IT teachers.

The related six items of teachers' questionnaire were examined with the intention of illuminating the topic and the frequency distributions of respondent results are shown in Table 13. First of all, teachers were required to assess the program whether it is adaptable to the local educational needs or not. Next, they evaluated

the courses and the modules of the program whether they have an updatable structure as claimed. After grasping teachers' opinions on the general principles of program flexibility, they were demanded to state their perception on the implementation of program flexibility in their schools with the five items of teachers' questionnaire in order to picture the actual situation.

Among 83 IT teachers, 31 (37,3 %) of them agreed or strongly agreed that the IT program is adaptable to the local educational needs with the mean of 3.05 (SD=.974). However, a significant part of the respondents were moderate and had not a certain opinion on the item with the proportion 34.9 %. And 23 (27.7 %) of the respondents disagree or strongly disagreed that the IT program is adaptable to the local educational needs.

On the other hand, if the IT teachers are required to assess whether the IT course and module contents have a structure that can be updateable parallel to the improvements in technology and science, more than half of them agreed (59 %) with the mean of 3.42 (SD=.977) whereas 34 (41 %) of the them had not a certain idea or disagreed on the topic. The frequency distributions of these two items are shown in *Figure 25* and *Figure 26*.

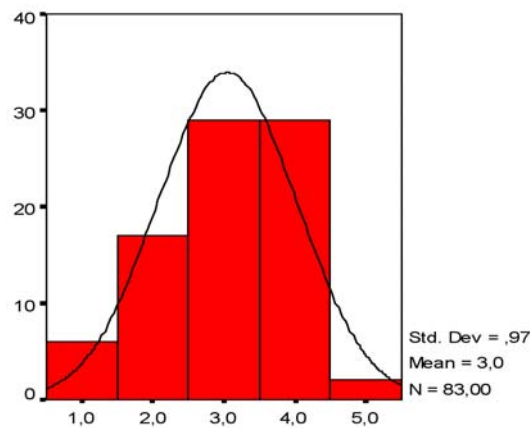

Figure 25. Frequency of item 1

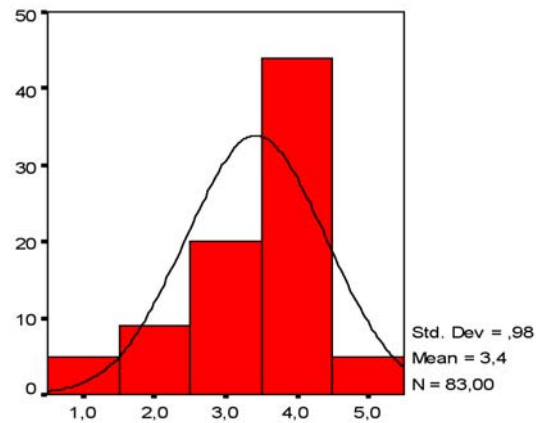

Figure 26. Frequency of item 2

The results of following four items from teachers' questionnaire related to actual implementation are represented also in Table 13. Accordingly among 83 IT teachers, an important number of them were inconsistent or disagreed that the program is adapted up to the local labour market needs in their schools environment with the proportion 71.1%. Only a minor part of the respondents were in agreement on the item (28.9 %) with the mean of 2.89 (SD=1.059).

Next, the largest group of the respondent IT teachers were uncertain that the program is adapted up to the local community needs in their schools environment with the number of 32 out of 83 (38.6 %). Likewise, 26 (31.3 %) of the respondents were strongly disagreed or disagreed on the item. However only 25 (30.1 %) of them were of the same mind that the program is adapted up to the local community needs in their schools environment with the mean of 2.93 (SD=1.045).

As illustrated in the table, 23 (27.7 %) of the IT teachers were indeterminate and 32 (38.6 %) of them strongly disagreed or disagreed that a committee is formed in their school that constituted of administrators, teachers and sector representatives for module selection and time allocation activities. Only about one-third (33.7 %) of the respondents agreed or strongly agreed on the item with the mean of 2.81 (SD=1.098).

Table 13. *Descriptive statistics of teachers on program flexibility*

Items		<i>f</i>	<i>p</i>	<i>M</i>	<i>SD</i>
1. Program is adaptable to the local educational needs	Strongly disagree	6	7.2	3.05	.974
	Disagree	17	20.5		
	Neither agree nor disagree	29	34.9		
	Agree	29	34.9		
	Strongly agree	2	2.4		
		n=83			
2. IT course and module contents have a structure that can be updateable parallel to the improvements in technology and science	Strongly disagree	5	6.0	3.42	.977
	Disagree	9	10.8		
	Neither agree nor disagree	20	24.1		
	Agree	44	53.0		
	Strongly agree	5	6.0		
		n=83			
3. Program is adapted up to the local labour market needs in our schools environment	Strongly disagree	10	12.0	2.89	1.059
	Disagree	17	20.5		
	Neither agree nor disagree	32	38.6		
	Agree	20	24.1		
	Strongly agree	4	4.8		
		n=83			
4. Program is adapted up to the local community needs in our schools environment	Strongly disagree	9	10.8	2.93	1.045
	Disagree	17	20.5		
	Neither agree nor disagree	32	38.6		
	Agree	21	35.3		
	Strongly agree	4	4.8		
		n=83			
5. A committee is formed in our school that constituted of administrators, teachers and sector representatives for module selection and time allocation a	Strongly disagree	13	15.7	2.81	1.098
	Disagree	19	22.9		
	Neither agree nor disagree	23	27.7		
	Agree	27	32.5		
	Strongly agree	1	1.2		
		n=83			

(Table 13. Continued)

6.Instructional activities progressing in cooperation with IT sector	Strongly disagree	9	10.8	2.78	1.037
	Disagree	24	28.9		
	Neither agree nor disagree	30	36.1		
	Agree	16	19.3		
	Strongly agree	4	4.8		
		n=83			

Lastly the sixth item of this part is assessing whether the instructional activities are processing in cooperation with IT sector. 33 (39.8 %) of the teachers strongly disagreed or disagreed and 30 (36.1 %) of them were undecided on the item. On the other hand, the fewer number (24.1 %) of the respondents agreed or strongly agreed that the instructional activities are processing in cooperation with IT sector with the mean of 2.78 (SD=1.037).

Further analyses were performed to determine if the teachers' perspective on application of program flexibility differ up to their awareness on program principles. Accordingly, two-way contingency table analyses were conducted to evaluate the effect of teachers' attendance at in-service training programs on the localization of the program. Firstly, teachers opinions on the item of "program is adapted up to the local labour market needs in our schools environment" and at least one time or more attendance at in-service training programs were found to be slightly significantly related, Pearson X^2 (df=2, n=82)=5.26, p=.07, Cramer's V=.25. The given proportions according to **Table 14**, teachers who attended in-service training programs one or more times more agreed (46 %) that they adapted the program up to the local labour market needs than the teachers (21 %) who did not attended any. Moreover, teachers opinions on the item of "Program is adapted up to the local community needs in our school environment" and at least one time or more attendance at in-service training programs were found to be significantly related, Pearson X^2 (df=2, n=82)=1.14, p=.05, Cramer's V=.12. Hence teachers who attended in-service training programs one or more times more agreed (39 %) that they adapted the program up to the local community needs than the teachers (27 %) who did not attended any.

Table 14. *Teachers' perspectives on program flexibility by attendance at in-service training programs*

Attendance at in-service training programs			
Program is adapted up to the local labour market needs in our schools environment, X^2 (df=2, n=82)=5.26, p=.07			
	Strongly disagree & disagree n=26 %	Neither agree nor disagree n=32 %	Strongly agree & agree n=24 %
None	35.7	42.9	21.4
One or more	23.1	30.8	46.2
Program is adapted up to the local community needs in our school environment, X^2 (df=2, n=82)=1.14, p=.05			
	Strongly disagree & disagree n=25 %	Neither agree nor disagree n=32 %	Strongly agree & agree n=25 %
None	32.1	41.1	26.8
One or more	26.9	34.6	38.5
A committee is formed in our school that constituted of administrators, teachers, and sector representatives for module selection and time allocation, X^2 (df=2, n=82)=5.86, p=.05			
	Strongly disagree & disagree n=32 %	Neither agree nor disagree n=23 %	Strongly agree & agree n=27 %
None	46.4	28.6	25
One or more	23.1	26.9	50
Instructional activities are processing in cooperation with IT sector, X^2 (df=2, n=82)=6.33, p=.04			
	Strongly disagree & disagree n=32 %	Neither agree nor disagree n=30 %	Strongly agree & agree n=20 %
None	48.2	30.4	21.4
One or more	19.2	50	30.8

Next, teachers opinions on the item of “A committee is formed in our school that constituted of administrators, teachers, and sector representatives for module

selection and time allocation” and at least one time or more attendance at in-service training programs were found to be significantly related, Pearson X^2 (df=2, n=82)=5.86, p=.05, Cramer's V=.26. Hence teachers who attended in-service training programs one or more times more agreed (50 %) that a committee is formed for instructional planning activities than the teachers (25 %) who did not attend any.

Lastly, teachers opinions on the item of “Instructional activities are processing in cooperation with IT sector” and at least one time or more attendance at in-service training programs were found to be significantly related, Pearson X^2 (df=2, n=82)=6.33, p=.04, Cramer's V=.28. Hence teachers who attended in-service training programs one or more times more agreed (31 %) or moderate (50 %) that they are in cooperation with industry than the teachers (21 %) who did not attend any.

Summary

In relation to program flexibility most of the teachers were of the same mind that IT course and module contents have a structure that can be updateable parallel to the improvements in technology and science. However, they did not reach a consensus on the adaptability of program to the local educational needs. Accordingly, if the implementation of program flexibility considered only a small proportion of the teachers concurred that a committee is formed, which constituted of administrators, teachers and sector representatives for instructional planning activities in cooperation with IT sector and therefore, the program is adapted up to the local labour market and community needs.

More importantly, a significant relationship was found between the implementation of the program flexibility and teachers’ awareness of the new program’s principles. Teachers who attended one or more times in-service training concurred that they were collaborating with local IT sector and they are adapting the framework program according to the local industry and community needs more than the teachers who did not attend any of in-service training activities.

Moreover, it was noticed that commerce vocational high school reached a consensus on the courses and weekly hours that will be implemented during an

academic year for the four departments of IT area at the 11th and 12th grades. The aim of this consensus was to support students' transactions between schools although this application was a lack of program flexibility and totally irrelevant to the new vocational system fundamentals.

4.3.2. Individual Flexibility

The sub-question related to this part is:

- Does the Vocational high school new IT curriculum supply individual flexibility?

In order to examine this sub-question data were gathered through The Evaluation Questionnaire of Vocational High Schools' Information Technology Area Curriculum for teachers applied to the IT teachers in vocational high schools and The Evaluation Questionnaire of Vocational High Schools' Information Technology Area Curriculum for students applied to the IT area 11th grade students.

The new IT curriculum aims to support individual flexibility with its modularized structure besides program flexibility. The intention of individual flexibility is the adaptability of educational program according to the students' demands or preferences. Accordingly, this research question wants to clarify whether the IT curriculum supplies individual flexibility from the viewpoints of IT teachers and IT area students.

The related six items of teachers' questionnaire and one item of students' questionnaire were examined with the intention of illuminating the topic and the frequency distribution of respondent results are shown in Table 15. First of all, teachers were required to assess the whether the program objectives can be formed up to the individual students' needs and interests or not. Next, they evaluated the content of new program if it is constructed on student centred approach as claimed. After grasping teachers' opinions on the general principles of individual flexibility, they were asked to express the implementation of individual flexibility in their schools with the four items of teachers' questionnaire in order to picture the actual situation. Furthermore, students were required to assess if they had an opportunity

to choose their occupational IT department according to their individual specialities.

Table 15. *Descriptive statistics of teachers and students on individual flexibility*

<i>Items</i>		<i>f</i>	<i>p</i>	<i>M</i>	<i>SD</i>
1.The objectives of the program can be formed up to the individual students' needs and interests	Strongly disagree	6	7.2	3.39	1.019
	Disagree	11	13.3		
	Neither agree nor disagree	17	20.5		
	Agree	45	54.2		
	Strongly agree	4	4.8		
		n=83			
2.The content is based on student centred approach	Strongly disagree	5	6.0	3.12	1.041
	Disagree	21	25.3		
	Neither agree nor disagree	20	24.1		
	Agree	33	39.8		
	Strongly agree	4	4.8		
		n=83			
3. Program is adapted up to the students' needs, interests and preferences in our school	Strongly disagree	8	9.6	3.00	1.059
	Disagree	19	22.9		
	Neither agree nor disagree	24	28.9		
	Agree	29	34.9		
	Strongly agree	3	3.6		
		n=83			
4. Program is adapted up to the students' current qualifications in our school	Strongly disagree	11	13.3	2.88	1.109
	Disagree	20	24.1		
	Neither agree nor disagree	23	27.7		
	Agree	26	31.3		
	Strongly agree	3	3.6		
		n=83			
5. Program is adapted up to the each students' progress rate in our school	Strongly disagree	11	13.3	2.66	.991
	Disagree	25	30.1		
	Neither agree nor disagree	29	34.9		
	Agree	17	20.5		
	Strongly agree	1	1.2		
		n=83			
6. Program is adapted up to the students' background experiences and learning methods in our school	Strongly disagree	18	21.7	2.33	.977
	Disagree	31	37.3		
	Neither agree nor disagree	24	28.9		
	Agree	9	10.8		
	Strongly agree	1	1.2		
		n=83			

(Table 15. Continued)

7.The department was my choice	Strongly disagree	79	11.6	3.89	1.406
	Disagree	67	9.8		
	Neither agree nor disagree	41	6.0		
	Agree	159	23.3		
	Strongly agree	337	49.3		
		n=683			

According to the statistics among 83 IT teachers, 49 (59 %) of them had the same opinion that the objectives of the program can be formed up to the individual students' needs and interests individual students' needs and interests with the mean of 3.36 (SD=1.019). Nevertheless, 34 (41 %) of them were undetermined or disagreed with the idea.

When the content is considered 37 (44.6 %) out of 83 IT teachers agreed or strongly agreed that the content of the new IT program is based on student centred approach with the mean of 3.12 (SD=1.041). On the other hand, 20 (24.1 %) of the respondents were unsure and 26 (31.3 %) of them disagreed with this item. The frequency distributions of these fundamental two items are shown in **Figure 27**.

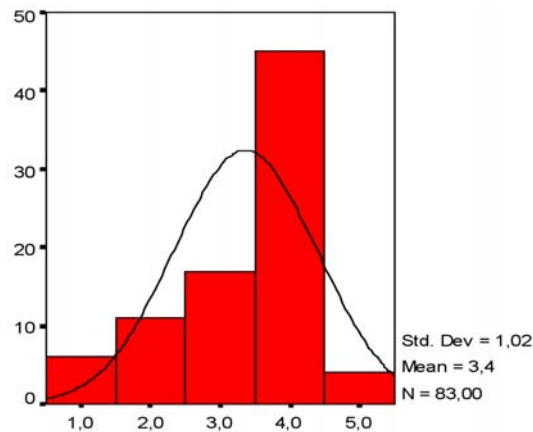

Figure 27. Frequency of item 1

The following five items are seeking the actual circumstances of individual flexibility in schools as represented with the frequency values in **Table 15**. Among 83 IT teachers, only 32 (38.5 %) of them concurred that the program is adapted up

to the students' needs, interests and preferences in their school with the mean of 3 (SD=1.059). 24 (28.9 %) of the respondents were undetermined and 27 (32.5 %) of them disagreed or strongly disagreed on the item. Similarly, only one-third (34.9 %) of the IT teachers concurred that the program is adapted up to the students' current qualifications in their school with the mean of 2.88 (SD=1.109). However, 23 (27.7 %) of the respondents were undetermined with the item and 31 (37.3 %) of them were opposed that the program is adapted up to the students' current qualifications.

Moreover 65 (78.3 %) of the teachers were uncertain or disagreed that the program is adapted up to the each student's progress rate in their school, while about one-fifth (21.7%) of them agreed with the item with the mean of 2.66 (SD=.991). Likewise, only 10 (12 %) of the respondents concurred that the program is adapted up to the students' background experiences and learning methods in their school with the mean of 2.33 (SD=.977). 49 (59 %) of them disagreed or strongly disagreed and 24 (28.9 %) of them had not a clear idea on the topic.

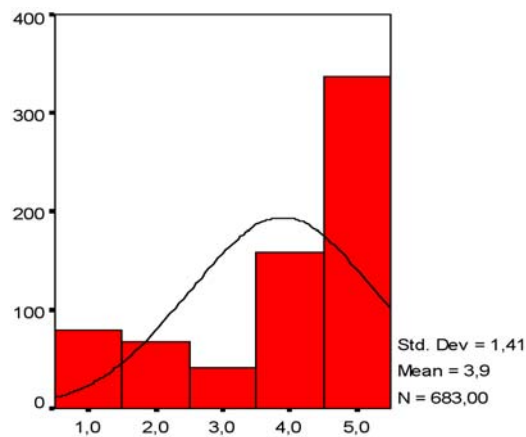

Figure 28. Frequency of item 7

The last item is seeking for whether the students selected their IT occupational branch by themselves. Among 683 IT area 11th grade students, 496 (72.6 %) of them agreed or strongly agreed that the branch was his choice with the mean of 3.89 (SD=1.406). However, 41 (6 %) of the students were undetermined and 146 (21.4 %) of them strongly disagree or disagree on the topic. The frequency

distribution of this item is represented in *Figure 28*.

Summary

In summary, most of the teachers were of the same mind that the objectives of the can be formed up to the individual students' needs and interests. However, less than half of them introduced the content as student centred.

The proportion of the teachers who concurred that the framework IT program was adapted up to the students' needs, interests and preferences or current qualifications is only about one-third. Moreover, only a small number of the teachers agreed that students' progress rate and background experiences and learning methods is considered in instructional activities.

4.3.3. Presentation Flexibility

The sub-question related to this part is:

- Does the Vocational high school new IT curriculum supply presentation flexibility?

In order to examine this sub-question data were gathered through The Evaluation Questionnaire of Vocational High Schools' Information Technology Area Curriculum for teachers applied to the IT teachers in vocational high schools and The Evaluation Questionnaire of Vocational High Schools' Information Technology Area Curriculum for students applied to the IT area 11th grade students.

The new modular IT curriculum aims to support presentation flexibility in which the students have a chance to follow the program at their own rates and accordingly, opportunity to quit or re-enter the system in different times. More importantly, presentation flexibility requires supporting training with a variety of educational methods for the students who have different backgrounds and interests. This research question aimed to clarify whether the IT curriculum supply presentation flexibility from the viewpoints of IT teachers and students.

The related two items of teachers' questionnaire were examined with the intention of illuminating the topic and the frequency distribution of respondent results are represented in **Table 16**. Furthermore, teachers were required to declare

which teaching methods and approaches and assessment and measurement techniques they use in their classes and what is the usage occurrence of them. These items were trying to grasp whether the teachers' aware of programs' presentation flexibility opportunities and if it is in action or not.

Next, the related four items of students' questionnaire were examined to comprehend if the students enacted individual learning and assessment principles as a result of the applied teaching methods and approaches and assessment and measurement techniques

Table 16. *Descriptive statistics of teachers on presentation flexibility*

Items		<i>f</i>	<i>p</i>	<i>M</i>	<i>SD</i>
1. Program offers the students to progress on their own rate and accordingly graduation in different times	Strongly disagree	17	20.5	2.64	1.154
	Disagree	21	25.3		
	Neither agree nor disagree	23	27.7		
	Agree	19	22.9		
	Strongly agree	3	3.6		
		n=83			
2. Program offers the students opportunity of exit the system early and to return back	Strongly disagree	10	12.0	3.04	1.098
	Disagree	13	15.7		
	Neither agree nor disagree	29	34.9		
	Agree	26	31.3		
	Strongly agree	5	6.0		
		n=83			

According to the statistics, 61 out of 83 IT teachers consented that the program does not offer the students to progress on their own rate and accordingly graduation in different times with the proportion of 73.5 %. Only 22 of them agreed or strongly agreed on the item with the mean of 2.64 (SD=1.154).

Correspondingly, only 31 (37.3 %) of the respondent IT teachers agreed that the program offers the students opportunity of exit the system early and to return back with the mean of 3.04 (SD=1.098). However, 52 (62.7 %) of them did not consent on the item or were undetermined. The frequency distributions of these two items

are represented in the *Figure 29* and *Figure 30*.

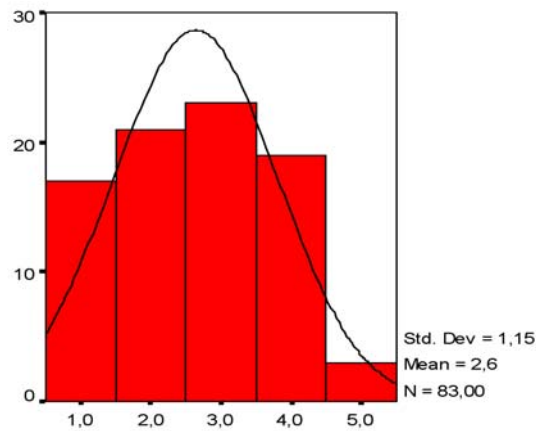

Figure 29. Frequency of item 1

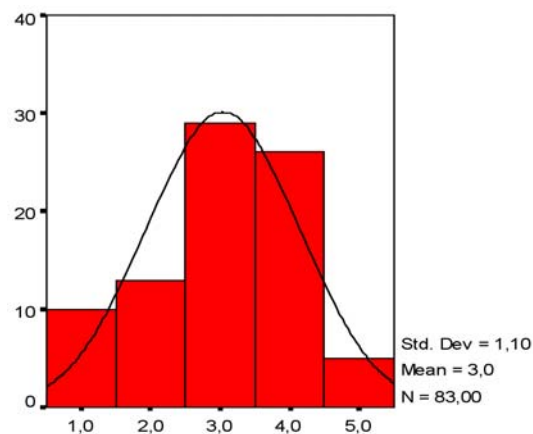

Figure 30. Frequency of item 2

Next, the teachers were required to degree the frequency of teaching methods and approaches that they use during the training activities to observe the implementation of presentation flexibility principle of the new program. In Table 17, below, the usage frequencies of teaching methods by 83 IT teachers are listed. 70 (84.3 %) of the respondents stated that they always or often use demonstration method during instruction. Demonstration is the most chosen teaching method during the instruction with the mean of 4.22 (SD=1.001). Moreover 63 (75.9 %) of them stated that they always or often use questioning method and following 50

(60.3 %) of them concurred that they always or often use lecturing method. Questioning is the second most chosen method with the mean of 3.92 (SD=.629) and lecturing follows them with the mean of 3.69 (SD=.825).

Nevertheless only 3 teachers always or often use field trip method with the mean of 1.67 (SD=.871). Role playing and interviewing follows it with the mean of 1.95 (SD=1.070) and 2.65 (SD=1.292).

Table 17. *Descriptive statistics of teaching methods and approaches*

Teaching methods and approaches		<i>f</i>	<i>p</i>	<i>M</i>	<i>SD</i>
Lecturing	Rarely	6	7.2	3.69	.825
	Sometimes	27	32.5		
	Often	37	44.6		
	Always	13	15.7		
		n=83			
Questioning	Sometimes	20	24.1	3.92	.629
	Often	50	60.2		
	Always	13	15.7		
		n=83			
Discussion	Never	4	4.8	3.27	.951
	Rarely	11	13.3		
	Sometimes	33	39.8		
	Often	29	34.9		
	Always	6	7.2		
		n=83			
Demonstration	Never	3	3.6	4.22	1.001
	Rarely	3	3.6		
	Sometimes	7	8.4		
	Often	30	36.1		
	Always	40	48.2		
		n=83			

(Table 17. Continued)

Group work	Never	9	10.8	3.17	1.228
	Rarely	15	18.1		
	Sometimes	26	31.3		
	Often	19	22.9		
	Always	14	16.9		
Project work		n=83			
	Never	4	4.8	3.57	1.084
	Rarely	6	7.2		
	Sometimes	32	38.6		
	Often	21	25.3		
Always	20	24.1			
Problem solving		n=83			
	Never	6	7.2	3.35	1.087
	Rarely	11	13.3		
	Sometimes	24	28.9		
	Often	32	38.6		
Always	10	12.0			
Field trip		n=83			
	Never	44	53.0	1.67	.871
	Rarely	26	31.3		
	Sometimes	10	12.0		
	Often	2	2.4		
Always	1	1.2			
Role playing		n=83			
	Never	35	42.2	1.95	1.070
	Rarely	28	33.7		
	Sometimes	12	14.5		
	Often	5	6.0		
Always	3	3.6			
Case study		n=83			
	Never	12	14.5	2.82	1.160
	Rarely	21	25.3		
	Sometimes	27	32.5		
	Often	16	19.3		
Always	7	8.4			
Brainstorming		n=83			
	Never	9	10.8	2.96	1.076
	Rarely	15	18.1		
	Sometimes	36	43.4		
	Often	16	19.3		
Always	7	8.4			
		n=83			

(Table 17. Continued)

Simulation	Never	11	13.3	2.94	1.141
	Rarely	17	20.5		
	Sometimes	27	32.5		
	Often	22	26.5		
	Always	6	7.2		
		n=83			
Interviewing	Never	18	21.7	2.65	1.292
	Rarely	25	30.1		
	Sometimes	17	20.5		
	Often	14	16.9		
	Always	9	10.8		
		n=83			

The assessment and measurement techniques also considered by the IT teachers, and they were required to degree the usage frequency of them to detect the new programs' presentation flexibility principle in action.

According to **Table 18** below, short answer items and multiple choice items are the most frequently used assessment and measurement techniques. 64 (80.1 %) of the respondent teachers stated that they always or often use short answer items with the mean of 3.82 (SD=.913) and 57 (68.7 %) of them assured that they always or often use multiple-choice items with the mean of 3.76 (SD=.820). Project work and module objective test follow them with the mean of 3.59 (SD=1.127) and 3.51 (SD=1.203).

Table 18. *Descriptive statistics of assessment and measurement techniques*

Assessment and measurement techniques		<i>f</i>	<i>p</i>	<i>M</i>	<i>SD</i>
Module objective test	Never	7	8.4	3.51	1.203
	Rarely	10	12.0		
	Sometimes	18	21.7		
	Often	30	36.1		
	Always	18	21.7		
		n=83			

(Table 18. Continued)

Module performance test	Never	5	6.0	3.48	1.193
	Rarely	14	16.9		
	Sometimes	19	22.9		
	Often	26	31.3		
	Always	19	22.9		
		n=83			
Performance task	Never	5	6.0	3.28	1.063
	Rarely	12	14.5		
	Sometimes	32	38.6		
	Often	23	27.7		
	Always	11	13.3		
		n=83			
Project work	Never	3	3.6	3.59	1.127
	Rarely	12	14.5		
	Sometimes	22	26.5		
	Often	25	30.1		
	Always	21	25.3		
		n=83			
Portfolio	Never	14	16.9	2.87	1.177
	Rarely	14	16.9		
	Sometimes	31	37.3		
	Often	17	20.5		
	Always	7	8.4		
		n=83			
Graded key	Never	18	21.7	2.76	1.255
	Rarely	16	19.3		
	Sometimes	24	28.9		
	Often	18	21.7		
	Always	7	8.4		
		n=83			
Check list	Never	19	22.9	2.75	1.208
	Rarely	12	14.5		
	Sometimes	27	32.5		
	Often	21	25.3		
	Always	4	4.8		
		n=83			
Concept map	Never	34	41.0	1.94	.980
	Rarely	27	32.5		
	Sometimes	16	19.3		
	Often	5	6.0		
	Always	1	1.2		
		n=83			

(Table 18. Continued)

Open response item	Never	12	14.5	3.10	1.154
	Rarely	10	12.0		
	Sometimes	24	28.9		
	Often	32	38.6		
	Always	5	6.0		
Short answer item		n=83			
	Never	4	4.8	3.82	.913
	Rarely	2	2.4		
	Sometimes	13	15.7		
	Often	50	60.2		
Always	14	16.9			
Multiple choice item		n=83			
	Rarely	7	8.4	3.76	.820
	Sometimes	19	22.9		
	Often	44	53.0		
Always	13	15.7			
Matching item		n=83			
	Never	26	31.3	2.35	1.120
	Rarely	18	21.7		
	Sometimes	23	27.7		
Often	16	19.3			
True/false test		n=83			
	Never	9	10.8	3.20	1.124
	Rarely	11	13.3		
	Sometimes	24	28.9		
	Often	32	38.6		
Always	7	8.4			
		n=83			

On the other hand, concept map is the least frequently used assessment and measurement technique. 61 (73.5 %) of the respondent teachers stated that they never or rarely use concept map in evaluation of students' achievement with the mean of 1.94 (SD=.980). Matching items and checklists follows it with the mean of 2.35 (SD=1.120) and 2.75 (1.208).

According to the represented frequencies in **Table 19**, among 683 students more than half them (63.8 %) were of the same opinion that they enjoy taking part into group works with the mean of 3.66 (SD=1.305) while 111 (16.3 %) of them were undetermined and 136 (19.9 %) of them were opposed on this item. Similarly, 430 (62.9 %) students concurred that they participate the lessons actively with the mean of 3.67 (SD= 1.126).

Moreover, 274 (40.1 %) students were of the same opinion that they are developing projects which solves real life problems during lessons with the mean of 3 (SD=1.326) but 409 (59.9 %) of them were uncertain or opposed on the item. Additionally, when they asked to consider if they are assessing themselves by using assessment questions in the modules, more than half of them (57.7 %) were in agreement on the item with the mean of 3.46 (SD=1.219).

Table 19. *Descriptive statistics of students on presentation flexibility*

<i>Items</i>		<i>f</i>	<i>p</i>	<i>M</i>	<i>SD</i>
1.I enjoy taking part into group works	Strongly disagree	72	10.5	3.66	1.305
	Disagree	64	9.4		
	Neither agree nor disagree	111	16.3		
	Agree	212	31		
	Strongly agree	224	32.8		
		n=68			
		3			
2.We are developing projects which solves real life problems during lessons	Strongly disagree	121	17.7	3	1.326
	Disagree	133	19.5		
	Neither agree nor disagree	155	22.7		
	Agree	171	25		
	Strongly agree	103	15		
		n=68			
		3			
3.I participate the lessons actively	Strongly disagree	42	6.1	3.67	1.126
	Disagree	60	8.8		
	Neither agree nor disagree	151	22.1		
	Agree	259	37.9		
	Strongly agree	171	25		
		n=68			
		3			
4.I can assess myself by using assessment questions in the modules	Strongly disagree	59	8.6	3.46	1.219
	Disagree	103	15.1		
	Neither agree nor disagree	127	18.6		
	Agree	252	36.9		
	Strongly agree	142	20.8		
		n=68			
		3			

Further analyses were performed to determine if the students' perspective on application of presentation flexibility differ up to the type of vocational high

school. According to the results of two-way contingency table analyses firstly students' opinions on the item of "I enjoy taking part into group works" and type of the school were found to be significantly related, Pearson X^2 (df=6, n=683)=26.32, p=.0, Cramer's V= .14. The given proportions according to Table 20, proportion of the students attending technical high schools agreed that they enjoy taking part into group works more than the students from vocational high schools, Anatolian vocational high schools and Anatolian technical high schools: .87, .70, .59, .58 respectively.

Similarly, students' opinions on the item of "We are developing projects which solves real life problems during lessons" and type of the school were found to be significantly related, Pearson X^2 (df=6, n=683)=19.43, p=.003, Cramer's V= .12. The given proportions of the students attending technical high schools agreed that they are developing projects which solves real life problems during lessons more than the students from Anatolian vocational high schools, vocational high schools, and Anatolian technical high schools: .65, .41, .37, .32 respectively.

Similarly, students' opinions on the item of "I participate the lessons actively" and type of the school were found to be significantly related, Pearson X^2 (df=6, n=683)=13.63, p=.03, Cramer's V= .1. The given proportions according to the table, proportion of the students attending technical high schools agreed that they participate the lessons actively more than the students from Anatolian vocational high schools, vocational high schools, and Anatolian technical high schools: .80, .64, .62, .55 respectively.

Lastly, students' opinions on the item of "I can assess myself by using assessment questions in the modules" and type of the school were found to be significantly related, Pearson X^2 (df=6, n=683)=21.84, p=.001, Cramer's V= .13. The given proportions of the students attending technical high schools agreed that they can assess themselves by using assessment questions in the modules more than the students from Anatolian vocational high schools, vocational high schools, and Anatolian technical high schools: .83, .57, .56, .51 respectively.

Table 20. *Students' perspectives on presentation flexibility by type of the school*

Type of the school		I enjoy taking part into group works, X^2 (df=6, n=683)=26.32, p=0		
		Strongly disagree & disagree	Neither agree nor disagree	Strongly agree & agree
		n=136 %	n=111 %	n=436 %
Anatolian Technical School	High	16.7	25.5	57.8
Technical School	High	4.3	8.7	87
Anatolian Vocational School	High	23.7	17.5	58.8
Vocational School	High	18.7	11.1	70.2
		We are developing projects which solves real life problems during lessons, X^2 (df=6, n=683)=19.43, p=.003		
		Strongly disagree & disagree	Neither agree nor disagree	Strongly agree & agree
		n=254 %	n=155 %	n=274 %
Anatolian Technical School	High	42.2	25.5	32.4
Technical School	High	10.9	23.9	65.2
Anatolian Vocational School	High	37.4	22	40.7
Vocational School	High	40.4	22.2	37.4
		I participate the lessons actively, X^2 (df=6, n=683)=13.63, p=.03		
		Strongly disagree & disagree	Neither agree nor disagree	Strongly agree & agree
		n=102 %	n=151 %	n=430 %
Anatolian Technical School	High	19.6	25.5	54.9
Technical School	High	6.5	13	80.4

(Table 20.Continued)

Anatolian Vocational School	High	16.6	19.9	63.5
Vocational School	High	11.6	26.3	62.1
I can assess myself by using assessment questions in the modules, X^2 (df=6, n=683)=21.84, p=.001				
		Strongly disagree & disagree	Neither agree nor disagree	Strongly agree & agree
		n=162 %	n=127 %	n=394 %
Anatolian Technical School	High	32.4	16.7	51
Technical School	High	0	17.4	82.6
Anatolian Vocational School	High	22.6	20.2	57.3
Vocational School	High	26.8	17.2	56.1

Summary

In summary, if the whole vocational education systems' presentation flexibility considered most of the teachers were opposed or undetermined that the program offers the students to progress on their own rate and accordingly graduation in different times or likewise exiting the system early and then returning back due to the lack of certification system. The fundamental principles of the program could not been executed properly because of the current old acts and regulations.

When referred to the instructional presentation flexibility of the new program, demonstration, questioning and lecturing are the most common used teaching methods and approaches by the IT teachers. However the teaching methods, which makes students more active, independent and responsive for their own learning such as group work, project work, case study or field trip are the less frequently used ones.

Similarly, the most frequently used assessment and measurement techniques are

short answer items, multiple choice items and project work while the individual assessment and measurement techniques such as module assessment tools, performance tasks and portfolio are used less frequently.

Teachers stressed that because of the not updated act and regulations, they must implement the instruction according to the old system's principles. So that they cannot use the teaching methods or assessment and measurement techniques appropriate to the new IT program and they are still continuing the conventional ones.

On the other hand, most of the students were of the same opinion that they enjoy taking part into group works and they participate the lessons actively. The students concurred that they are assessing themselves by using assessment questions in the modules. Nevertheless less than half of them agreed that they are developing projects, which solves real life problems during lessons. Additionally, when they were compared based on their school type, students attending technical high schools are more motivated to learn dynamically into group works inline with the principles of the program than the other schools' students.

4.3.4. Educational Route Flexibility

The sub-question related to this part is:

- Does the Vocational high school new IT curriculum supply educational route flexibility?

In order to examine this sub-question data were gathered through The Evaluation Questionnaire of Vocational High Schools' Information Technology Area Curriculum for teachers applied to the IT teachers in vocational high schools.

The new modular IT curriculum aims to support educational route flexibility in which the students should have a chance follow their own way by selecting among courses or modules. Furthermore, the transaction opportunities should be provided between training areas and between the departments within areas as well.

The related two items of teachers' questionnaire were examined with the intention of illuminating the topic and the frequency distribution of respondent results are shown in **Table 21**. These items were an attempt to recognize whether the

educational route flexibility enacted in implementation phase of the new IT curriculum.

Table 21. *Descriptive statistics of teachers on educational route flexibility*

<i>Items</i>		<i>f</i>	<i>p</i>	<i>M</i>	<i>SD</i>
1.Program offers the students to follow their individual way by selecting among courses	Strongly disagree	17	20.5	2.81	1.204
	Disagree	15	18.1		
	Neither agree nor disagree	21	25.3		
	Agree	27	32.5		
	Strongly agree	3	3.6		
		n=83			
2.Program offers the students to follow their individual way by selecting among modules	Strongly disagree	18	21.7	2.69	1.199
	Disagree	19	22.9		
	Neither agree nor disagree	20	24.1		
	Agree	23	27.7		
	Strongly agree	3	3.6		
		n=83			

According to the represented frequencies 30 (36.1 %) out of 83 IT teachers agreed or strongly agreed that the program offers the students to follow their individual way by selecting among courses with the mean of 2.81 (SD=1.204). Anyway, 53 (63.9 %) of them were not were of the same opinion or had not a certain perspective on the topic.

Correspondingly, only 26 (31.3 %) of IT teachers were in agreement that the program offers the students to follow their individual way by selecting among modules with the mean of 2.69 (SD=1.199). The frequency distributions of these two items are represented in *Figure 31* and *Figure 32*.

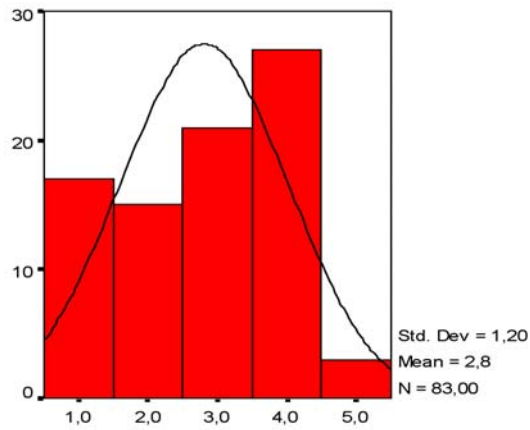

Figure 31. Frequency of item 1

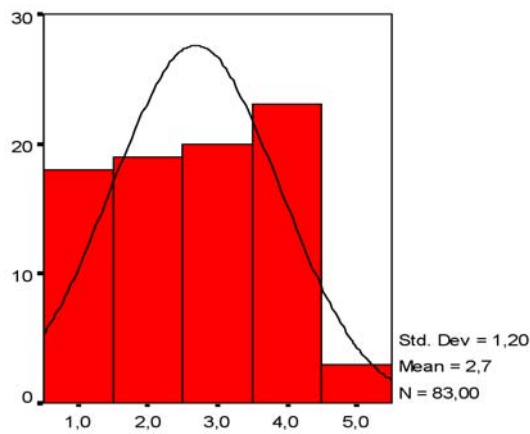

Figure 32. Frequency of item 2

Summary

In summary, most of the teachers were of the same opinion that the program does not support the occasion of tracking an individual way to students by making selections among courses or modules.

Moreover, it was detected that the new vocational education system does not provide students transactions between occupational areas or departments similar to the old system. The only transaction is possible between vocational and general high schools during or at the end of the common 9th grade.

4.4. Educational Settings of IT curriculum

The research question related to this part of result is:

- To what extent are the educational settings (students, teachers, schools infrastructures and modules) suitable for to be implementation of the Vocational high schools' new IT curriculum in the way it is intended?

This research question will be investigated in the following parts with predicating on the perceptions of teachers and students.

4.4.1. *Students*

The sub-question related to this part is:

- Do the students have proposed abilities for learning with new IT curriculum?

In order to examine this sub-question data were gathered through The Evaluation Questionnaire of Vocational High Schools' Information Technology Area Curriculum for teachers applied to the IT teachers in vocational high schools and The Evaluation Questionnaire of Vocational High Schools' Information Technology Area Curriculum for students applied to the IT area 11th grade students.

In order to be successful in the new curriculum, students basically should have the ability of learning individually by following the modules and obviously this type of instruction should be their preference. Hence, they should be informed on how to learn with modular curriculum. Additionally the program should be adequate to the level of students and they should have sufficient reading and comprehension abilities to follow the modules on their own. These principles of the new program evaluated from the viewpoints of teachers through the five items of teachers' questionnaire and three items of students' questionnaire.

The perspective of the teachers on students learning with new modular IT curriculum is represented in **Table 22**. Among 83 IT teachers, 35 (42.2 %) out of 83 teachers concurred that the program is appropriate for students level with the mean of 3.04 (SD=1.064). On the other hand, 48 (57.8 %) of them were opposed

or undetermined on the item.

Table 22. *Frequency distribution of teachers on students*

<i>Items</i>	<i>f</i>	<i>p</i>	<i>M</i>	<i>SD</i>
1.Program is appropriate for students level	Strongly disagree	7	8.4	3.04 1.064
	Disagree	21	25.3	
	Neither agree nor disagree	20	24.1	
	Agree	32	38.6	
	Strongly agree	3	3.6	
	n=83			
2.The students reading and comprehending abilities are proper to follow the modules individually	Strongly disagree	10	12.0	2.87 1.045
	Disagree	18	21.7	
	Neither agree nor disagree	31	37.3	
	Agree	21	25.3	
	Strongly agree	3	3.6	
	n=83			
3.Program includes the materials for disadvantaged students to follow the modules individually	Strongly disagree	18	21.7	2.40 1.059
	Disagree	29	34.9	
	Neither agree nor disagree	24	28.9	
	Agree	9	10.8	
	Strongly agree	3	3.6	
	n=83			
4.The students are informed on how to learn with this program	Strongly disagree	11	13.3	2.72 1.063
	Disagree	27	32.5	
	Neither agree nor disagree	20	24.1	
	Agree	24	28.9	
	Strongly agree	1	1.2	
	n=83			
5.The students have enough time and opportunities to perform the required studies	Strongly disagree	7	8.4	2.98 1.059
	Disagree	24	28.9	
	Neither agree nor disagree	18	21.7	
	Agree	32	38.9	
	Strongly agree	2	2.4	
	n=83			

Likewise, 28 (33.7 %) of the IT teachers were opposed and 31 (37.3) of them were uncertain that the students reading and comprehending abilities are proper to follow the modules individually. Only 24 (28.9 %) of them agreed or strongly agreed with the item with the mean of 2.87 (SD=1.045). The frequency distributions of these two items are represented in *Figure 33* and *Figure 34*.

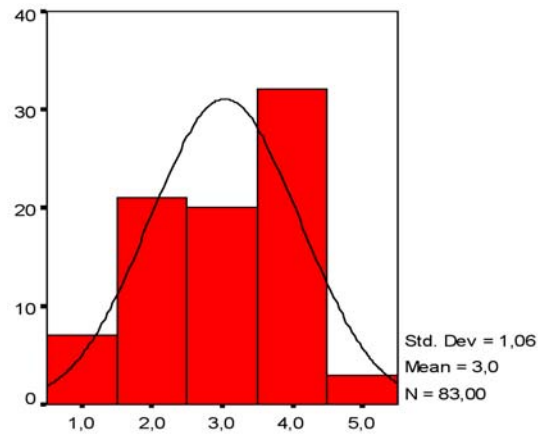

Figure 33. Frequency of item 1

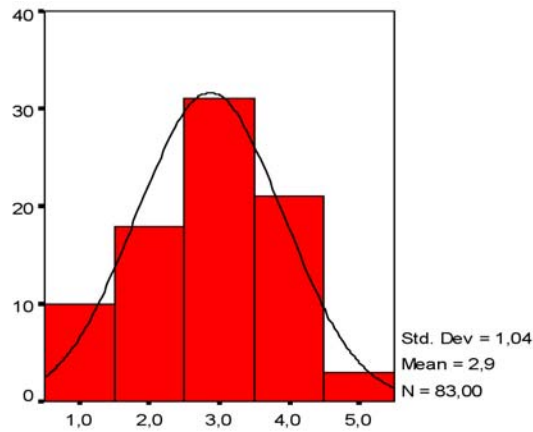

Figure 34. Frequency of item 2

Furthermore, 25 (30.1 %) teachers agreed or strongly agreed that the students were informed on how to learn with the new program with the mean of 2.72 (SD=1.063). Nevertheless, 58 (69.9 %) of them were opposed or uncertain with the item. If the teachers were required to assess whether the students have enough time and opportunities to perform the required studies of the new program, 34 (41 %) of them were in agreement with the mean of 2.98 (SD=1.059) while 49 (59 %) of them were opposed or uncertain on the item.

When the perspective of the students on learning new modular IT curriculum considered as is represented in Table 23 among 683 IT area 11th grade students,

276 (40.4 %) of them were of the same opinion that they can study the courses themselves by following the modules with the mean of 2.97 (SD=1.332) while 153 (22.4 %) of them were undetermined and 254 (37.2 %) of them were opposed on the item.

Table 23. *Descriptive statistics of students on learning new program*

<i>Items</i>		<i>f</i>	<i>p</i>	<i>M</i>	<i>SD</i>
1.I can study the courses myself by following the modules	Strongly disagree	132	19.3	2.97	1.332
	Disagree	122	17.9		
	Neither agree nor disagree	153	22.4		
	Agree	187	27.4		
	Strongly agree	89	13.0		
		n=683			
2.I can understand the topic after my teacher explanations	Strongly disagree	39	5.7	3.66	1.184
	Disagree	88	12.9		
	Neither agree nor disagree	134	19.6		
	Agree	225	32.9		
	Strongly agree	197	28.8		
		n=683			
3.I prefer learning the topic from teacher, instead of learning from module individually	Strongly disagree	25	3.7	4.28	1.044
	Disagree	31	4.5		
	Neither agree nor disagree	60	8.8		
	Agree	179	26.2		
	Strongly agree	388	56.8		
		n=683			

Accordingly, 567 (83 %) of the students agreed or strongly agreed that they prefer learning the topic from teacher, instead of learning from module individually with the mean of 4.28 (SD=1.044) but 60 (8.8 %) of them undetermined and 56 (8.2 %) of them opposed with the item. Moreover, about two-third of the students concurred that they can understand the topic after their teacher's explanations with the mean of 3.66 (SD=1.184).

Summary

In summary of the results, less than half of the teachers were of the same opinion that students' reading and comprehending abilities are proper to follow the modules individually and they have enough time and opportunities to perform the

required studies. Likewise, most of the teachers were opposed or uncertain that the program is appropriate to students' level and they are informed on how to learn with this program. Additionally, only a slight proportion of them agreed that the program includes the materials for disadvantaged students to follow the modules individually.

Teachers remarked that students are accustomed to learning with conventional methods and they have not adopted the new individual teaching learning perceptive yet. Students are not aware of the change in learner's role with the new program. They prefer to learn with conventional methods in a teacher centred environment instead of taking the responsibility of their own learning. Thus, the whole comprehension of the program will take some time.

From the viewpoint of students, most of them were opposed or uncertain that they can study the courses themselves by following the modules so that they prefer learning the topic from teacher, instead of learning from module individually. In the same way, most of them were of the same opinion that they can understand the topic after their teacher's explanations.

4.4.2. Teachers

The sub-question related to this part is:

- Do the teachers have proposed abilities for teaching with new IT curriculum?

In order to examine this sub-question data were gathered through The Evaluation Questionnaire of Vocational High Schools' Information Technology Area Curriculum for teachers applied to the IT teachers in vocational high schools.

Teachers are important key players in the implementation process of the new IT curriculum as they are the responsible bodies to arrange the learning activities in line with the program's principles. Therefore in order to succeed the program, teachers should be very well informed on the characteristics, objectives and content of the program and they should be supported on their problems. The related items of teachers' questionnaire were investigated to grasp whether teachers are favour of the new program and whether they are facing problems in

action because of information deficiencies.

Table 24. *Descriptive statistics of teachers on teaching new program*

<i>Items</i>	<i>f</i>	<i>p</i>	<i>M</i>	<i>SD</i>
1.I have required information on the objectives and implementation of program	Strongly disagree	2	2.4	3.75 .935
	Disagree	6	7.2	
	Neither agree nor disagree	19	22.9	
	Agree	40	48.2	
	Strongly agree	16	19.3	
	n=83			
2.I am the master of program content	Strongly disagree	3	3.6	3.20 1.124
	Disagree	25	30.1	
	Neither-agree nor disagree	18	21.7	
	Agree	26	31.3	
	Strongly agree	11	13.3	
	n=83			
3.I am the master of program application activities	Strongly disagree	5	6.0	3.25 1.157
	Disagree	20	24.1	
	Neither agree nor disagree	19	22.9	
	Agree	27	32.5	
	Strongly agree	12	14.5	
	n=83			
4.The introduction seminars and meetings of program were sufficient	Strongly disagree	24	28.9	2.33 1.170
	Disagree	25	30.1	
	Neither agree nor disagree	23	27.7	
	Agree	5	6.0	
	Strongly agree	6	7.2	
	n=83			
5.Program supplies necessary resources and materials to the teachers	Strongly disagree	26	31.3	2.25 1.167
	Disagree	31	37.3	
	Neither agree nor disagree	6	7.2	
	Agree	19	22.9	
	Strongly agree	1	1.2	
	n=83			
6.I can solve problems related to program with the meetings in my school	Strongly disagree	18	21.7	2.58 1.191
	Disagree	24	28.9	
	Neither agree nor disagree	21	25.3	
	Agree	15	18.1	
	Strongly agree	5	6.0	
	n=83			

(Table 24.Continued)

7.Program has problems that can not be solved by the support of school	Strongly disagree	5	6.0	3.43	1.222
	Disagree	17	20.5		
	Neither agree nor disagree	17	20.5		
	Agree	25	30.1		
	Strongly agree	19	22.9		
		n=83			
8.I need in-service teacher training on new the topics of program	Strongly disagree	8	9.6	3.47	1.373
	Disagree	19	22.9		
	Neither agree nor disagree	6	7.2		
	Agree	26	31.3		
	Strongly agree	24	28.9		
		n=83			

The frequency distributions of teachers' perspective on teaching new IT program are represented in **Table 24**. Among 83 IT teachers, 56 (67.5 %) of them agreed or strongly agreed that they have required information on the objectives and implementation of program with the mean of 3.75 (SD=.935) while 27 (32.5 %) of them were uncertain or opposed on the item.

Less than half of them were of the same opinion that they have mastered the program content and the program application activities with the mean of 3.20 (SD=1.124) and with the mean of 3.25 (SD=1.157), respectively.

Accordingly, only 11 (13.2 %) of them were in an agreement that the introduction seminars and meetings of the program were sufficient with the mean of 2.33 (SD=1.170). Thus, 50 (60.2 %) of them agreed that they need in-service teacher training on new the topics of program with the mean of 3.47 (SD=1.373). Nevertheless, 63 (75.9 %) of them were not of the same opinion or unsure that the program supplies the necessary resources and materials to them while 20 (24.1 %) of them agreed on the item with the mean of 2.25 (SD=1.167).

Likewise, only 20 (24.1 %) of the teachers concurred that they can solve problems related to program with the meetings in their school with the mean of 2.58 (SD=1.191) while 63 (75.9 %) of them were unsure or opposed with the item. Additionally, 44 (53 %) of the teachers concurred that program has problems that cannot be solved by the support of school with the mean of 3.43 (SD=1.222).

If the in-service teacher training programs considered expressly, 50 (60.2 %) out of 83 IT teachers were of the same mind that they need in-service teacher training on the new topics of the program with the mean of 3.47 (SD=1.373) while 33 (39.8 %) of them were uncertain or opposed on the item. The frequency distribution is represented in *Figure 35*.

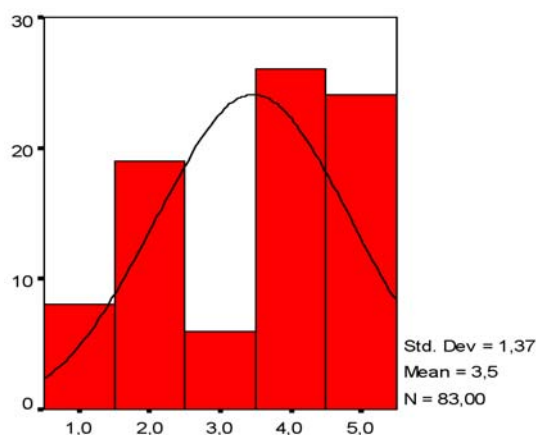

Figure 35. Frequency of item 8

Table 25. Frequency distributions of teachers on attendance at in-service training

			<i>f</i>	<i>p</i>
Attendance at in-service training programs	None		56	68.3
	Once		12	14.6
	Twice		3	3.7
	More than two times		11	13.4
			n=82	

Accordingly as represented in **Table 25**, among 82 IT teachers 56 (68.3 %) of them proposed that they didn't attend in-service training programs on new IT curriculum. 12 of them once, 3 of them twice and 11 of them more than two times attended in-service training programs. Additionally according to **Table 26**, among these 26 attended IT teachers only 8 of them evaluated the in-service training programs as very helpful while 12 of them were undetermined and 6 of them were opposed that the in-service training programs were helpful.

Table 26. *Frequency distributions of teachers on evaluation of in-service training*

			<i>f</i>	<i>p</i>
Evaluation of in-service training programs	Very helpful		8	30.8
	Moderately		12	46.2
	Not helpful		6	23.1
			n=26	

Summary

In summary of the results, most of the teachers were of the same opinion that they have required information on the objectives and implementation of program despite the fact that most of them complained about the insufficient introduction seminars and meetings and resources and materials. Additionally, most of them were in agreement that the program has some problems that cannot be solved within the school environment.

Likewise, less than half of the teachers were of the same opinion that they are the masters of program content and application activities. Accordingly, most of them concurred that that they didn't attend in-service training programs on the new topics of the program although they need. The teachers who attended in-service training assessed these activities as not effective.

Even worse, they remarked that these activities were beneficial for comprehending the fundamentals of new vocational education system but they were very short and not covering in dept information on application of program principles' into instruction. Moreover, teachers stressed that the new IT program is totally an innovation in terms of its structure and topics, hence they need effective in-service training that are supported by the expert trainers in addition to short introduction seminars.

More importantly, teachers stated that the curriculum change enacted without wholly investigation of the current status of the teachers and students as well. Their opinions did not taken into account during the curriculum development and change processes so that their comprehension and adequately implementation of the new system will take some time.

4.4.3. School quality indicators

The sub-question related to this part is:

- Are the school quality indicators inline with the needs of new IT curriculum?

In order to examine this sub-question data were gathered through The Evaluation Questionnaire of Vocational High Schools' Information Technology Area Curriculum for teachers applied to the IT teachers in vocational high schools and The Evaluation Questionnaire of Vocational High Schools' Information Technology Area Curriculum for students applied to the IT area 11th grade students

The new vocational schools' IT curriculum requires technical support for successfully implementation since it is an innovation for the schools in terms of its structure and content. MoNE introduced the needed standard equipments, facilities and materials in schools for each four occupational profiles of IT area. Hence firstly, the technical infrastructure of the schools should be adapted according to these standards. Then, the learning environments should be arranged appropriate to provide the students the chance of individual study.

The six items of teachers questionnaire and one item of students' questionnaire were investigated to comprehend whether the infrastructure of the schools satisfactory to actualize the program successfully. Firstly, the teachers were required to assess if the laboratories, equipments, materials and facilities and also classrooms are satisfactory.

Additionally, they were asked if they arrange the instruction inline with their schools infrastructure circumstances. Next, the students were required to assess whether they can easily access the needed resources.

Table 27. *Descriptive statistics of teachers on school quality indicator*

<i>Items</i>		<i>f</i>	<i>p</i>	<i>M</i>	<i>SD</i>
1.The laboratories (computer, electronics, hardware, network etc) are sufficient in our school	Strongly disagree	2	2.4	3.43	1.061
	Disagree	17	20.5		
	Neither agree nor disagree	20	24.1		
	Agree	31	37.3		
	Strongly agree	13	15.7		
		n=83			
2.The equipments and materials of laboratories are sufficient in our school	Strongly disagree	2	2.4	3.30	1.101
	Disagree	23	27.7		
	Neither agree nor disagree	18	21.7		
	Agree	28	33.7		
	Strongly agree	12	14.5		
		n=83			
3.The hardware and software facilities are sufficient in our school	Strongly disagree	6	7.2	3.31	1.168
	Disagree	16	19.3		
	Neither agree nor disagree	20	24.1		
	Agree	28	33.7		
	Strongly agree	13	15.7		
		n=83			
4.The classrooms of our school are organized in a way that the students can study individually	Strongly disagree	11	13.3	2.99	1.215
	Disagree	20	24.1		
	Neither agree nor disagree	19	22.9		
	Agree	25	30.1		
	Strongly agree	8	9.6		
		n=83			
5.The classrooms of our school have the libraries that contain written and visual resources	Strongly disagree	15	18.1	2.48	1.183
	Disagree	39	47.0		
	Neither agree nor disagree	9	10.8		
	Agree	14	16.9		
	Strongly agree	6	7.2		
		n=83			
6.Our schools' infrastructure and resource circumstances are considered in module selection and time allocation	Strongly disagree	10	12.0	3.19	1.244
	Disagree	17	20.5		
	Neither agree nor disagree	13	15.7		
	Agree	33	39.8		
	Strongly agree	10	12.0		
		n=83			

According to frequencies in Table 27, among 83 IT teachers 44 (53 %) of them were of the same opinion that the laboratories (computer, electronics, hardware, network etc) are sufficient in their school with the mean of 3.43 (SD=1.061) while 20 (24.1 %) of them were moderate and 19 (22.9 %) of them were opposed on the item. 40 (48.2 %) of the teachers agreed that the equipments and materials of laboratories are also sufficient in their school with the mean of 3.30.

Similarly, 41 (49.4 %) of the teachers concurred that the hardware and software facilities are sufficient in their school with the mean of 3.31 (SD=1.168) while 20 (24.1 %) of them were moderate and 22 (26.5 %) of them were opposed on the item.

Furthermore, 33 (39.7 %) out of 83 IT teachers were of the same opinion that the classrooms of their school are organized in a way that the students can study individually with the mean of 2.99 (SD=1.215) nevertheless 19 (22.9 %) of them were undetermined and 31 (37.3 %) of them were against the item.

Likewise only 20 (24.1 %) of the teachers concurred that these classrooms have the libraries that contain written and visual resources with the mean of 2.48 (SD=1.183), on the other hand 63 (75.9 %) of them were undetermined or against the item. As a result, 43 (51.8 %) of the teachers stated that they consider their schools' infrastructure and resource circumstances in module selection and time allocation activities of instruction with the mean of 3.19 (SD=1.244) while 40 (48.2 %) of them were moderate and opposed on the item

Further analyses were performed to determine if the teachers' perspectives on school quality indicators differ up to general directorate their school linked. Accordingly, two-way contingency table analyses were conducted to investigate this effect. Firstly, teachers opinions on the item of "The laboratories (computer, electronics, hardware, network etc) are sufficient in our school" and the linked general directorate of the schools were found to be slightly significantly related, Pearson X^2 (df=4, n=83)=16.47, p=.002, Cramer's V= .32. The given proportions according to **Table 28**, teachers from the schools linked to DG of Commerce and Tourism Education were of the same opinion that the laboratories are sufficient in their school more than the teachers from the schools linked to DG of Technical

Education for Boys and DG of Technical Education for Girls: .85, .41 and .35 respectively.

Table 28. *Teachers' perspectives on school quality indicators by General Directorate of the School*

General Directorate of the School			
The laboratories (computer, electronics, hardware, network etc) are sufficient in our school, X^2 (df=4, n=83)=16.47, p=.002			
	Strongly disagree & disagree	Neither agree nor disagree	Strongly agree & agree
	n=19 %	n=20 %	n=44 %
DG of Commerce and Tourism Education	7.7	7.7	84.6
DG of Technical Education for Boys	32.4	27	40.5
DG of Technical Education for Girls	25	40	35
The equipments and materials of laboratories are sufficient in our school, X^2 (df=4, n=83)=10.74, p=.03			
	Strongly disagree & disagree	Neither agree nor disagree	Strongly agree & agree
	n=25 %	n=18 %	n=40 %
DG of Commerce and Tourism Education	19.2	7.7	73.1
DG of Technical Education for Boys	37.8	24.3	37.8
DG of Technical Education for Girls	30	35	35
The hardware and software facilities are sufficient in our school, X^2 (df=4, n=83)=11.99, p=.017			
	Strongly disagree & disagree	Neither agree nor disagree	Strongly agree & agree

(Table 28. Continued)

	n=22 %	n=20 %	n=41 %
DG of Commerce and Tourism Education	15.4	7.7	76.9
DG of Technical Education for Boys	29.7	32.4	37.8
DG of Technical Education for Girls	35	30	35

In addition to teachers' perception on school quality indicators, among 683 students 430 (63 %) of them were uncertain or opposed that they can easily reach the resource books that they need while 253 (37 %) of them were in agreement on the item with the mean of 2.91 (SD=1.239) as represented in **Table 29**.

Table 29. Frequency distribution of students on school quality indicators

Item		<i>f</i>	<i>p</i>
I can easily reach the resource books that I need	Strongly disagree	111	16.3
	Disagree	158	23.1
	Neither agree nor disagree	161	23.6
	Agree	187	27.4
	Strongly agree	66	9.7
		n=683	

Summary

In summary of the results, about half of the IT teachers were of the same mind that the laboratories and the equipments and materials of the laboratories and the hardware and software facilities are sufficient in their school. There are, on the other hand, considerable variations in school' infrastructural resources and facilities depending on the DG they linked. Teachers from the schools linked to DG of Commerce and Tourism Education assessed that infrastructural resources and facilities are much more available in their schools than the teachers from the schools linked to DG of Technical Education for Boys and DG of Technical

Education for Girls.

However, only a small proportion of the teachers were of the same mind that the classrooms of their school are organized in a way that the students can study individually and these classrooms have the libraries that contain written and visual resources. Similarly, most of the students were also agreed that they could not easily reach the needed resource books.

Teachers remarked that because of the deficiencies in laboratories, equipments and materials they sometimes could not find the opportunity of performing application activities hence they had to teach related topic in theory. Additionally, in some schools teachers complained that they could not divide the class into small manageable groups in order to support adequately execution of application activities thus they had to control whole class altogether. In some cases, even they divide the class into small groups but at this time two or more teachers had to use the same laboratory together.

Moreover it was detected that in most of the schools financial support have not been taken for constructing the required infrastructural resources and facilities so that they are trying to implement the new IT program with the laboratories and equipments remaining from old program.

More importantly, because of the infrastructural deficiencies most of the schools had to orient the students appropriate departments that could be implemented in their school. As a result according to the statistics represented in **Table 4**, 447 (65.4 %) out of 683 students attend training on the Web programming department of IT area. Database Programming follows it with the percentage of 23.4 % while Network Management and Computer Technical Service were the less preferred departments with the percentages of 6 % and 5 %.

4.4.4. Modules

The sub-question related to this part is:

- Do the modules of the new IT curriculum meet the needs of students and teachers?

In order to examine this sub-question data were gathered through The Evaluation Questionnaire of Vocational High Schools' Information Technology Area Curriculum for teachers applied to the IT teachers in vocational high schools and The Evaluation Questionnaire of Vocational High Schools' Information Technology Area Curriculum for students applied to the IT area 11th grade students.

Table 30. *Descriptive statistics of teachers on modules functional linkages*

<i>Items</i>		<i>f</i>	<i>p</i>	<i>M</i>	<i>SD</i>
1. The connection among modules within a course is well constructed	Strongly disagree	5	6.0	3.04	.981
	Disagree	20	24.1		
	Neither agree nor disagree	28	33.7		
	Agree	27	32.5		
	Strongly agree	3	3.6		
		n=83			
2. Modules are prerequisite of each other	Strongly disagree	4	4.8	3.39	.998
	Disagree	14	16.9		
	Neither agree nor disagree	16	19.3		
	Agree	44	53.0		
	Strongly agree	5	6.0		
		n=83			

One of the important innovations of new vocational high schools IT curriculum is its modularized structure. Modules are the basic instructional building block of new curriculum, which have logically self-integrity and functional linkages to each other. With this research question, first of all teachers were required to assess if the linkages between IT modules are well constructed in a way they are prerequisite to each other. Next, the teachers evaluated the objectives, standards, content, application activities, statements and guidelines of the modules. They also evaluated the supported opportunities for individual and group study of the modules. Furthermore, the students were required to assess content, application activities, statements and guidelines of the modules as well in order to grasp their perspective on the same topic. Consequently, the intention is to comprehend whether modularized IT instruction is implemented successfully in action through investigating the fundamental unit of the program 'module'.

Next as stated in Table 31, among 83 IT teachers 56 (67.4 %) of them were of the same mind that modules include the initiation statements that explains the occupational advantages to students with the mean of 3.55 (SSD=. 927) but 27 (32.5 %) of them were opposed or uncertain on the item.

However, slightly more than one-third of the teachers concurred that the selected conditions and standards are well defined within the modules with the mean of 3.14 (SD=1.002). Nevertheless, only 27 (32.5 %) of the IT teachers concurred that the statements in the modules are clear and easily comprehensible while 32 (38.6 %) of them were opposed and 24 of them (28.9 %) were uncertain on the item.

Furthermore, if the guidelines and explanations in the modules were considered, 30 (36.1 %) of the teachers concurred that they are sufficient for students' individual study with the mean of 2.94 (SD=1.016) but 53 (63.9 %) of them were uncertain or opposed on the item. Similarly, more than three-fourth of the teachers were uncertain or opposed that the content of the modules organized in way that support the students' individual progress.

Likewise, only 22 (26.5 %) of them were of the same opinion that modules include plenty of application activities to achieve the occupational skills with the mean of 2.76 (SD=.995). Additionally, only 18 (21.7 %) of the teachers concurred that the content of the modules is supported with a variety of examples with the mean of 2.60 (SD=1.011).

30 (36.1 %) of teachers were agreed that the teachers and students could easily handle the modules with the mean of 2.72 (SD=1.391) but 53 (63.9 %) of them were uncertain or opposed on the item. More than three-fourth of them stated that the instructional processes would be easier if all the modules are ready.

Table 31. *Descriptive statistics of teachers on modules*

<i>Items</i>		<i>f</i>	<i>p</i>	<i>M</i>	<i>SD</i>
3.Modules include the initiation statements that explains the occupational advantages to students	Strongly disagree	3	3.6	3.55	.927
	Disagree	10	12.0		
	Neither agree nor disagree	14	16.9		
	Agree	50	60.2		
	Strongly agree	6	7.2		
		n=83			
4.The statement in the modules are clear and easily comprehensible	Strongly disagree	10	12.0	2.87	1.102
	Disagree	22	26.5		
	Neither agree nor disagree	24	28.9		
	Agree	23	27.7		
	Strongly agree	4	4.8		
		n=83			
5.Modules include the guidelines and explanations for students individual study	Strongly disagree	6	7.2	2.94	1.016
	Disagree	25	30.1		
	Neither agree nor disagree	22	26.5		
	Agree	28	33.7		
	Strongly agree	2	2.4		
		n=83			
6.The selected conditions and standards are well defined within the modules	Strongly disagree	4	4.8	3.14	1.002
	Disagree	17	20.5		
	Neither agree nor disagree	32	38.6		
	Agree	23	27.7		
	Strongly agree	7	8.4		
		n=83			
7.The content of the modules organized in way that support the students' individual progress	Strongly disagree	8	9.6	2.65	.981
	Disagree	32	38.6		
	Neither agree nor disagree	27	32.5		
	Agree	13	15.7		
	Strongly agree	3	3.6		
		n=83			
8.Modules include plenty of application activities to achieve the occupational skills	Strongly disagree	7	8.4	2.76	.995
	Disagree	30	36.1		
	Neither agree nor disagree	24	28.9		
	Agree	20	24.1		
	Strongly agree	2	2.4		
		n=83			

(Table 31.Continued)

9.The content of the modules are supported with a variety of examples	Strongly disagree	10	12.0	2.60	1.011
	Disagree	33	39.8		
	Neither agree nor disagree	22	26.5		
	Agree	16	19.3		
	Strongly agree	2	2.4		
		n=83			
10.The teachers and students can easily handle the modules	Strongly disagree	23	27.7	2.72	1.391
	Disagree	16	19.3		
	Neither agree nor disagree	14	16.9		
	Agree	21	25.3		
	Strongly agree	9	10.8		
		n=83			
11.The Instructional processes will be easier if all the modules are ready	Strongly disagree	5	6.0	4.14	.843
	Disagree	9	10.8		
	Agree	38	45.8		
	Strongly agree	31	37.3		
			n=83		

In Table 32 the frequency distributions of items related to opportunities supported for students are listed. Accordingly, 23 (27.7 %) of the teachers were of the same opinion that modules offer students the opportunities of collaboration, group work and taking responsibility with the mean of 2.78 (SD=1.060) while rest of them were moderate or opposed on the item with the proportion of 72.3 %.

Likewise, 28 (33.7 %) of the IT teachers concurred that modules offer students the opportunities of research, preparation of project work and presentation with the mean of 3.01 (SD=. 930) but 30 (36.1 %) of them were moderate and 25 (30.1 %) of them were opposed on the item. 35 (42.2 %) of the teachers agreed that modules offer students the opportunity of self-assessment with the mean of 3.11(SD=.988).

More then one-third of the students were of the same opinion that the knowledge and applications in the modules are satisfactory level with the mean of 2.94 (SD=1.156) while 217 (31.8 %) of them moderate and 230 (33.7 %) of them opposed on the item . Likewise, 249 (36.5 %) of the students concurred that modules include sufficient example related to topic with the mean of 2.93 (SD=1.160) but 435 (63.5 %) of them were uncertain or opposed on the item.

Table 32. *Descriptive statistics of teachers on modules' offers*

<i>Items</i>	<i>f</i>	<i>p</i>	<i>M</i>	<i>SD</i>
12. Modules offer the opportunities of collaboration, group work and taking responsibility	Strongly disagree Disagree Neither agree nor disagree Agree Strongly agree	10 24 26 20 3	12.0 28.9 31.3 24.1 3.6	2.78 1.060
	n=83			
13. Modules offer the opportunities of research, preparation of project work and presentation	Strongly disagree Disagree Neither agree nor disagree Agree Strongly agree	4 21 30 26 2	4.8 25.3 36.1 31.3 2.4	3.01 .930
	n=83			
14. Modules offer the opportunity of self assessment	Strongly disagree Disagree Neither agree nor disagree Agree Strongly agree	6 16 26 33 2	7.2 19.3 31.3 39.8 2.4	3.11 .988
	n=83			

Moreover, 329 (48.2 %) out of 683 students were of the same mind that they could easily perform the application activities by following the steps with the mean of 3.28 (SD=1.197) while 185 (27.1 %) of them were moderate and 169 (24.7 %) of them were opposed on the item. However, two-third of the students were uncertain or opposed that they can easily find research topics while 228 (33.3 %) of them were in agreement on the item.

Table 33. *Descriptive statistics of students on modules*

<i>Items</i>	<i>f</i>	<i>p</i>	<i>M</i>	<i>SD</i>
1. The content of the modules are very clear and understandable	Strongly disagree Disagree Neither agree nor disagree Agree Strongly agree	106 137 213 169 58	15.5 20.1 31.2 24.7 8.5	2.91 1.184
	n=683			

(Table 33.Continued)

2.Modules include sufficient example related to topic	Strongly disagree	95	13.9	2.93	1.160
	Disagree	151	22.1		
	Neither agree nor disagree	188	27.5		
	Agree	202	29.6		
	Strongly agree	47	6.9		
		n=683			
3.The knowledge and applications in the modules are satisfactory level	Strongly disagree	97	14.2	2.94	1.156
	Disagree	133	19.5		
	Neither agree nor disagree	217	31.8		
	Agree	184	26.9		
	Strongly agree	52	7.6		
		n=683			
4.I can easily perform the application activities by following the steps	Strongly disagree	74	10.8	3.28	1.197
	Disagree	95	13.9		
	Neither agree nor disagree	185	27.1		
	Agree	226	33.1		
	Strongly agree	103	15.1		
		n=683			
5.I can easily find research topics	Strongly disagree	78	11.4	2.95	1.090
	Disagree	146	21.4		
	Neither agree nor disagree	231	33.8		
	Agree	186	27.2		
	Strongly agree	42	6.1		
		n=683			

Summary

In summary of the results, first of all most of the teachers were of the same opinion that modules include the initiation statements that explains the occupational advantages to students nevertheless only about one-third of them agreed that the statement in the modules are clear and easily comprehensible and the selected conditions and standards are well defined within the modules. Teachers also remarked that the content of the modules includes wrong and incomprehensible statements and some of them are overly theoretical thus above the level of students. In parallel with the teachers, most of the students were opposed or uncertain that the content of the modules are very clear and understandable.

Most of the teachers were opposed or undetermined that modules include the guidelines and explanations for students' individual study hence they stated that the content of the modules organization does not support the students'

individual progress. Likewise, plenty of teachers and students stated that the content of the modules is not supported sufficient examples and application activities as well. Additionally, the figures and visual elements of the content are not satisfactory.

If the teachers assessed the usability of modules by the students, about one-third of the teachers were of the same opinion that modules offer students the opportunities of research, preparation of project work, presentation and self-assessment as well. Nevertheless, the number of teachers who concurred that, modules offer students the opportunities of collaboration, group work and taking responsibility is very low.

More importantly, teachers criticized that modules were not prepared by the experts of the subjects and were not checked entirely hence they include lots of incomplete and wrong examples and application activities. Dramatically, plenty of the content were directly taken from the Internet resources without any modification for these reason modules include lots of useless parts irrelevant to the topic.

Next, most of the teachers were of the same opinion that they are having problems in handling the modules because modules can only be reachable from the website of project MEGEP in electronic format and the printed versions of the modules were not supported for the teachers and students as well. They stressed that they have taken financial support for module printing for students firstly in this year however this support was not enough to print all the modules. Therefore, most of the teachers concurred that the instructional processes would be easier if all the modules are ready. Another significant problem with the modules is although the new IT program is action for three years, there are still the modules that are not ready to use.

Moreover, one-third of the students concurred that they can easily find research topics and less than half of the students were of the same mind that they could easily perform the application activities by following the steps.

Lastly, most of the teachers were of the same opinion that modules are prerequisite of each other and the connection among modules within a course is well

constructed.

4.4.5. Problems faced during instruction

Problems faced during instruction by the teachers in implementation of new IT program are examined in this section. In Table 34 descriptive statistics of these problems are represented from beginning with the most frequently encountered one. Accordingly, 74 out of 83 respondent teachers expressed that incomplete modules are the most general problem of the new IT program in implementation with the mean of 4.37 (SD=.946). Lack of laboratory and teacher guidebooks are the second commonly faced problem by the teachers with the mean of 3.84 (1.065). Necessity of additional resources because of insufficient modules follows them with the mean of 3.64 (1.205).

Table 34. *Descriptive statistics of Problems faced during instruction*

Items		<i>f</i>	<i>p</i>	<i>M</i>	<i>SD</i>
1.Incomplete modules	Strongly disagree	2	2.4	4.37	.946
	Disagree	4	4.8		
	Neither agree nor disagree	3	3.6		
	Agree	26	31.3		
	Strongly agree	48	57.8		
		n=83			
2.Lack of laboratory and teacher guidebooks	Strongly disagree	3	3.6	3.84	1.065
	Disagree	7	8.4		
	Neither agree nor disagree	15	18.1		
	Agree	33	39.8		
	Strongly agree	25	30.1		
		n=83			
3.Necessity of additional resources because of insufficient modules	Strongly disagree	4	4.8	3.64	1.205
	Disagree	15	18.1		
	Neither agree nor disagree	11	13.3		
	Agree	30	36.1		
	Strongly agree	23	27.7		
		n=83			
4.Limited time for applications because of heavy content	Strongly disagree	5	6	3.52	1.263
	Disagree	18	21.7		
	Neither agree nor disagree	11	13.3		
	Agree	27	32.5		
	Strongly agree	22	26.5		
		n=83			

(Table 34. Continued)

5.Performing applications with an excessive number of student group	Strongly disagree	4	4.8	3.42	1.270
	Disagree	24	28.9		
	Neither agree nor disagree	8	9.6		
	Agree	27	32.5		
	Strongly agree	20	24.1		
n=83					
6.Lack of laboratory equipments	Strongly disagree	6	7.2	3.25	1.157
	Disagree	18	21.7		
	Neither agree nor disagree	19	22.9		
	Agree	29	34.9		
	Strongly agree	11	13.3		
n=83					
7.Theoretical instruction because of equipment and material deficiencies	Strongly disagree	6	7.2	3.23	1.223
	Disagree	22	26.5		
	Neither agree nor disagree	16	19.3		
	Agree	25	30.1		
	Strongly agree	14	16.9		
n=83					
8.Limited access to modules	Strongly disagree	10	12	3.17	1.296
	Disagree	20	24.1		
	Neither agree nor disagree	12	14.5		
	Agree	28	33.7		
	Strongly agree	13	15.7		
n=83					
9.Difficulties in connecting topics to daily life	Strongly disagree	3	3.6	3	1.036
	Disagree	30	36.1		
	Neither agree nor disagree	19	22.9		
	Agree	26	31.3		
	Strongly agree	5	6		
n=83					
10.Limited usage of visual materials (films, slides, models)	Strongly disagree	8	9.6	2.80	1.145
	Disagree	33	39.8		
	Neither agree nor disagree	17	20.5		
	Agree	18	21.7		
	Strongly agree	7	8.4		
n=83					

Moreover, more than half of the teachers were in agreement that limited time for applications because of heavy content and performing applications with an excessive number of student group are the important problems of the program in action with the mean of 3.52 (SD=1.263) and 3.42 (SD=1.270).

Next, slightly less than half of the teachers also remarked lack of laboratory equipments, theoretical instruction because of equipment and material

deficiencies, and limited access to modules are the encountered problems during instruction.

And lastly, difficulties in connecting topics to daily life and limited usage of visual materials (films, slides, models) are the less frequently faced problems in implementation.

The findings of the study were presented in this chapter addressing each research question. In the next chapter, conclusions drawn from Evaluation Questionnaire of s Vocational High Schools' Information Technology Area Curriculum for teachers and students and implications for practice and future research are presented.

CHAPTER 5

CONCLUSIONS AND IMPLICATIONS

This chapter includes an interpretation and synthesis of the findings and conclusions, implications and suggestions for future research drawn from “Evaluation Questionnaire of Vocational High Schools’ Information Technology Area Curriculum for teachers”, “Evaluation Questionnaire of Vocational High Schools’ Information Technology Area Curriculum for students”.

5.1. Conclusions

Findings concerning objectives and content of Vocational high schools’ new IT curriculum, the degree of actualized flexibility in execution of curriculum and the required educational settings for adequately implementation of curriculum are represented in this section.

5.1.1. *Demands of IT labour market*

Perceptions of IT teachers were investigated to capture whether the objectives and the content of new IT curriculum meets the needs of global, national and local IT labour markets.

The results of this study showed that, the objectives of the new program are inline with the new developments in global IT sector and these objectives are catching the demanded skills in the world of work compared with the old program (see Table 6 and Table 7).

Similarly if the content of the program is considered, slightly less than half of the respondent teachers stated that the program content is satisfactory to actualize the introduced objectives on the whole. The content of the 10th grade (common grade of area), or the 11th and 12th grades’ (department specific grades) are satisfactory to accomplish the specific skills of area. Nevertheless, more than half of the

teachers assessed the generic skills (i.e. adaptability to work environment, good communication) of the program as not sufficient (see Table 6 and Table 8).

More importantly, it was found that the perceptions of the teachers on the 11th and 12th grade departmental content differ up to the their school's linked DG. Thus, they agreed that new IT program is more fitting the intentions of vocational high schools linked to DG of Technical Education for Boys (see Table 9).

When the needs of national IT labour markets taken into account, most of the respondent teachers were in agreement that the objectives of the program are responsive to countrywide demands. They also concurred that the four departments of IT area supports the required occupational profiles by the national IT sector (see Table 10).

Moreover, the results proved that the objectives of the new IT program meet the needs of local IT industry and the requirements and expectations of local community as well. More than half of the teachers were in agreement on this idea (see Table 11).

All vocational high schools began to implement an IT program based on a common framework with the new system, differently from the old structure. The results confirmed that the content of the new IT program is more responsive to the purposes of vocational high schools linked to DG of Technical Education for Boys. It is more technical and theoretical comparing with the old IT programs of vocational high schools linked to DG of Commerce and Tourism Education and DG of Technical Education for Girls (see Table 12).

5.1.2. Adaptability of IT curriculum

The perceptions of IT teachers and 11th grade IT area students' in vocational high schools were investigated to capture whether the new IT program is flexible. Flexibility in this context used as a term that refers to the program's adaptability capacity. The new modular IT program should be adaptable to the rapidly changing skill requirements of industry and technology and to the demands or preferences of students'. Furthermore, it should provide a chance for students to follow their own way by selecting among courses or modules. Students should

also have the opportunity of transferring between training areas and between the departments within areas.

Program flexibility

According to the findings of the study, most of the respondent teachers were of the same opinion that in principle new IT program course and module contents have an updateable structure inline with the improvements in science and technology. Nevertheless, only 31 out of 83 of them agreed on that the program is adjustable to the local educational needs (see Table 13)

Appropriately, when the actual implementation circumstances are considered only in the minority of vocational high schools a committee was formed to adapt the program to the local labour market and community needs. Therefore, instructional planning activities were not mostly executed in cooperation with local IT sector and the adaptability of program did not succeed as proposed (see Table 13).

More seriously, Vocational high schools linked to DG of Commerce and Tourism Education in Ankara reached a consensus on the courses and weekly hours of the IT program in order to support students' transactions between schools. This consensus, unfortunately, causes lack of program flexibility and totally irrelevant to the new vocational system fundamentals.

Moreover, it is resolved that the IT teachers do not have sufficient information on new IT program's philosophy and implementation principles because of insufficient initiation meetings and in-service training attempts. For this reason, they are not efficient in collaborating with local IT sector and adapting the framework program according to the local needs of industry and community. According to the results, teachers who attended one or more times in-service training activities comprehended the program fundamentals better so that they are capable of implementing flexibility inline with program intentions (see Table 14).

Individual Flexibility

In relation to the results of the related data, on the whole the new IT program is more responsive to the students' needs, interests and preferences compared with the old one. More than half the respondent teachers had the same idea that the objectives of the program can be shaped based on individual students'

characteristics in structure. However, most of them judged program content as not student centred completely (see Table 15)

When the enactment of individual flexibility principle considered, the framework IT program has not been adapted up to the students' needs, interests and preferences or current qualifications in most of the schools.

Even worse, only a minority of the teachers declared that students' progress rates, background experiences and learning methods were taken into account in instructional activities (see Table 15).

Presentation Flexibility

One of the significant innovations of new IT program is certification system, which aims to assess students up to their skill acquisition and document this with a certificate according to their success. Certification system offers students the flexibility of exiting or re-entering the vocational education system. Nevertheless, during the past three years of program implementation, the certification system have not been effectuated because of the old act and regulations and undetermined skill requisitions for certification levels.

Similarly, only one-third of the respondents IT teachers were in agreement that the new IT program offers students the opportunity of exiting the system early before graduation and then returning back after a while. The rest of them were undetermined or disagreed on the issue. Worse still, the number of the teachers who agreed that the program provides the students to progress on their own rate and accordingly to graduate in different times is only 22 out of 83 (see Table 16)

When instructional presentation flexibility of the program considered, the results confirmed that the teaching methods making students more active and independent such as group work, project work, case study or field trip are not the mostly preferred ones. On the other hand, teachers use traditional teaching methods such as demonstration, questioning and lecturing most frequently. Accordingly, the results proved that they always or often use demonstration method with the proportion of 84.3% and questioning method with the 75.9% while they always or often use project work with the proportion of 49.4% and group work with the proportion of 39.8% (see Table 17).

The commonly usage of demonstration method is inevitable in the domain of Information Technology. On the other hand, more effective teaching methods should have been preferred instead of lecturing or questioning inline with the new program's student centred viewpoint so as to enhance students' participation and as a result skill comprehension.

Moreover, according to the results of assessment and measurement techniques usage frequency, short answer items, multiple-choice items and project work are the most frequently used ones. However, the other assessment techniques that are vital for IT skill evaluation such as performance tasks and portfolio are used less frequently than the others. The teachers stated that they always or often use short answer items with the proportion of 80.1% , multiple-choice items with the proportion of 68.7% and project work with the proportion of 55.4% whereas they always or often use performance test with the proportion of 41% and portfolio with the proportion of 28.9% (see Table 18).

Although short answer items and multiple-choice items are very effective assessment techniques because of their applicability and evaluation in a short time, they are not the appropriate techniques for computer related skill acquisitions. On the other hand, it is good that project work is one of the common used techniques. It is an individual assessment technique, which provides students the opportunity of application so that easily comprehension of learned skills. More importantly, it provides teachers the opportunity of grasping each student's level of learning parallel to the philosophy of new IT curriculum 'students centred learning'.

The new IT curriculum requires more contemporary teaching and assessment methods inline to its modular and competency based structure. Nevertheless, teachers complained that the act and regulations related to assessment and measurement have not been updated yet. Thus, they have to implement program up to the conventional methods and techniques. This old act and regulations do not let them to teach or evaluate with more individual performance focused methods. For instance teachers still have to rank students success with written and oral exams.

If the respondent students' point of view on methods and techniques taken into

consideration, the results proved that more than half of them enjoy taking part into group works and they participate the lessons actively. Most of them stated that they are using assessment questions in the modules to evaluate themselves (see Table 19).

However the students criticised that the developed projects during lessons are not solving real life problems so that they are not sufficient to prepare them to the work life. Additionally, when the students compared based on their school type, students attending technical high schools are more motivated to learn dynamically into group works. They participate lessons actively and assess themselves by using individual assessment questions in the modules inline with the principles of new program (see Table 20).

Educational Route Flexibility

The results of the teachers' data proved that the new IT program do not support an individual way to students via making selections among courses or even worse among modules. The instructional activities were not planned up to the each student's needs, preferences or background (see Table 21)

More importantly, transactions between occupational areas or departments within the vocational education system are not supported with the new IT program. When the whole educational system considered, the only transaction is possible between vocational and general high schools during only the common grade of 9th but not at the upper grades. However, the new vocational system claims to overcome the bluff isolation between vocational and general education systems and to make them getting closer to each other. Consequently according to the results, it can be stated that the new IT program do not support the flexibility of deciding on educational paths even inside or outside of the system.

5.1.3. Appropriateness of educational settings

The IT teachers and 11th grade IT area students' perceptions were explored to capture whether the educational settings suitable for implementing the new IT program as intended. Therefore, students' and teachers' related capabilities; schools' infrastructural circumstances and program modules were investigated in

order to examine this phenomenon.

Students

According to the results of the study, 35 out of 83 of the teachers were of the same opinion that the new IT program is appropriate to the level of students' intellectual capacity and even worse only 24 of them agreed that students reading and comprehending abilities are not sufficient to follow the modules individually. Furthermore, less than half of the teachers agreed that the students' have sufficient opportunities to perform required studies of the program however most of them thought that students were not informed on how to learn with the new program (see Table 22).

Likewise, students supported the idea of teachers on the teaching learning styles of new program. Thus as the results showed, most of the students prefer learning the topic from teacher, instead of learning from module individually. They stressed that they can only appreciate the topics in the case of after their teacher's explanations (see Table 23).

Consequently, it can be affirmed that neither the teachers nor the students aware of change in their role with the new program. They are familiar to conventional methods so that they have not adopted the individualist teaching learning perceptive in principle completely. Students still continue to learn through conventional methods in a teacher centred environment instead of taking the responsibility of their own learning. The totally comprehension and enactment of new program's contemporary perceptive will take some time.

Teachers

According to the related data of the teachers, most of them were aware of the objectives and implementation principles of the new program, on the other hand, more than half of them remarked that they were not well grounded in program content and application activities. Insufficient introduction seminars and meetings could be regarded as the cause of this problem (see Table 24).

Accordingly, 68.3% of the teachers concurred that that they didn't attend any in-service training programs on the new topics of program. The 69.3% of the rest who attended one or more times evaluated in-service training programs

as moderately helpful or not helpful. For that reason, teachers urgently need professional in-service training to efficiently train in new curriculum (see **Table 25** and **Table 26**)

Moreover, most of the teachers assessed that the necessary resources and materials of new program were not supplied to them and more seriously, the program has some emergent problems that cannot be solved inside the school environment with the efforts of teachers and administrators (see Table 24).

More essentially, teachers' current capabilities or beliefs on new program were not examined and taken into consideration throughout the curriculum development or implementation processes, therefore the adaptation of teachers will take some time.

School quality indicators

The results of the study showed that the laboratories, equipments and materials of the laboratories are mostly sufficient in the examined vocational high schools. In addition to laboratories, teachers assessed the hardware and software facilities as satisfactory in their schools. However schools' infrastructural resources do not have a standard, because they didn't updated up to the new curriculum. They differ up to the school's linked General Directorate.

According to the old structure of the IT training, vocational high schools were implementing different IT programs based on the objectives and intentions of the DG they linked hence the infrastructural resources are different in schools. The results proved that these resources are much more available in the vocational schools linked to DG of Commerce and Tourism Education compared with schools linked to DG of Technical Education for Boys and DG of Technical Education for Girls (see Table 27 and **Table 28**)

Accordingly, because of shortages in the number of laboratories teachers couldn't divide the class into small groups so that they have to teach application activities to whole class of students' altogether or even worse two or more teachers have to use the same laboratory together. Likewise, teachers also complained that they are sometimes facing with laboratory, equipment or material deficiencies, in this case, therefore, they have to teach topics theoretically.

In order to succeed in the new program schools' physical circumstances should be arranged in a way that supports the opportunity of individual study. Anyhow, the results illustrated that classrooms are not organized appropriately in most of the schools. More importantly, only in a small number of the schools there are libraries, which contain written and visual resources related to the IT area, to support students' independent studies. Correspondingly, only 37.1% of the respondent students were in agreement that it is easy to reach the required resource books (see **Table 29**)

The new vocational programs, on the other hand, have the structure that supports the programs' adaptability to the school's available physical resources in order to improve the success rate of program objectives. However in about half of the schools, infrastructure and resource circumstances were not considered in instructional planning phase. This situation will result in to fall short of program objectives (see Table 27)

More importantly, the infrastructural circumstances were not as good as to support the four departments of IT area in most of the vocational high schools. As a result, about 65% of the IT area students were attending training on Web programming profile in Ankara. Nevertheless, Network Management and Computer Technical Service were the less preferred profiles with the percentages of 6 % and 5 %. Although in the new program the intention is training the students in one of the departments of IT area that should be selected according to the needs of local labour markets, the lack of infrastructure circumstances obstruct it (see Table 4).

Modules

The results of the study proved that firstly, the initiation statements of the modules that explain the occupational advantages to students are sufficient from the perspective of teachers. Modules are organized in a way that is prerequisite of each other's and the connection among them within a course is well constructed (see Table 31 and Table 32)

However, both the teachers and students assessed that in the modules the statements are not very clear and easily comprehensible. Some of the statements are wrong or overly theoretical and above the level of students. Hence, they are not

suitable for individual progress through the program (see Table 31 and **Table 33**)

Next, their organization does not support students' individual study because of deficiencies in guidelines and explanations and unsatisfactory examples and application activities. Additionally, the content are not supported by enough the figures and visual elements.

Teachers pointed out that modules contain incomplete and wrong examples and application activities. Responsible teachers who prepared the modules were not the experts of the subjects and modules were not checked strictly before started to use in terms of its subject matter or language rules as well. Dramatically, plenty of the topics were directly taken from the Internet resources without any adaptation for that cause modules include lots of useless parts irrelevant to content.

Another problem of the modules is their availability. Although this research was performed on the third year of new program's implementation, MoNE still did not publish some of the modules. Modules are only reachable from the website of project MEGEP in electronic format and the printed versions of them are not supported. Even worse, schools did not get completely financial support for module printing. As a result, teachers emphasised that the instructional processes would be easier if all the modules are ready.

And lastly, if the practice of modules considered teachers were of the same mind that modules offer students the opportunities of research, preparation of project works, presentation and self-assessment in some how. Students also commented that it is not so easy to find the research topics. Nevertheless, the number of teachers who concurred that, modules offer students the opportunities of collaboration, group work and taking responsibility is very low (see Table 32 and Table 33).

5.2. Implications for Teaching and Learning

Evaluation studies are quite necessary for optimal functioning of curriculum. Conclusions drawn from these studies are valuable for curriculum improvement. As this study is a formative evaluation effort, in the light of gathered data obstacles of the program can be revised before they cause crucial problems in the future.

The following suggestions obtained from the results of study, should taken into account in revision process.

1. The content of the program includes sufficient area specific skills, so that it is satisfactory on the whole to actualize the objectives. The generic skills, on the other hand, are not sufficient enough hence the program should be enhanced to this direction.
2. The 11th and 12th grade departmental content is more considering the general purposes of vocational high schools linked to DG of Technical Education for Boy, therefore it should be revised in a way that is more responsive to all types of vocational high school's intentions.
3. The relationships between the vocational high schools and local IT industry should be strengthened so as to actualize the adaptation of the program up to the local needs. Additionally, sector representatives should be included in the instructional planning activities.
4. Vocational high schools should be more autonomous on implementation of the program. They should have the independence of arranging the courses and weekly hours of them up to their students' profiles and infrastructural resources.
5. In adaptation of framework IT program students' needs, interests and preferences or current qualifications should be taken into consideration. Students' progress rates, background experiences and learning methods are also important concerns in the program adaptation.
6. The current act and regulations should be updated in order to actualize certification system that provides skill validation of students leaving the system early.
7. Teaching methods, which make students more active and independent such as group work, project work, case study or field trip should be used more often by the teachers instead of traditional ones.

Similarly in students' assessment, the used methods should be appropriate to computer related skill acquisition and they should be inline with the

program's modular and competency-based structure.

8. Educational pathways should be enriched in a way that provides students to follow an individual way by making choices among courses or among modules. Furthermore, the transaction occasions between the vocational and general high schools, occupational areas and departments should be enhanced.
9. The new program should be revised appropriate to the students' intellectual level, and reading and comprehending capacity as well to support individual progress of them through the modules. Additionally, students should be well informed on learning styles of new program.
10. Teachers should be supported with in-service training activities on the content and implementation principles of the new program. The area experts should perform these activities more effectively. The necessary program resources and materials should also be supplied to the teachers.
11. The new IT program should include the required directions and additional materials for disadvantaged students.
12. The required laboratories, equipments and materials should be supplied to vocational high schools inline with the IT area standards. Especially, the infrastructural resources in vocational high schools' linked to DG of Technical Education for Boys and DG of Technical Education for Girls should be advanced.

Otherwise, instructional activities should be organized considering the infrastructure and resource circumstances so as to realize the program objectives in actual fact.

13. In Ankara about 65% of the IT area students were attending training on Web programming profile. Nevertheless, other departments i.e. Network Management and Computer Technical Service are the less preferred profiles. This situation will cause an enormous problem for the graduates' employability in labour markets. In order to handle this obstacle, there should be a state-wide plan for selection of occupational profiles based on

the requirements of local IT market.

14. The learning environment should provide students' the opportunity individual study. Therefore, the classrooms and laboratories should be arranged properly. Related written and visual resources should also be supplied to support students' self progress.
15. As the modules are self-pacing learning units, they should include necessary guidelines and explanations. The statement in the modules also should be clear and easily comprehensible appropriate to the students' level. Furthermore, the topics in the modules should be supported with a variety of examples and visual components. Thus, in order to achieve these intentions modules should be prepared and checked by the area experts' truthfulness.

Although the program is in action for three years when the research was performed, there were still unprepared modules. Moreover, the access to the modules is a crucial problem both for the students and teachers. Hence, the deficient modules should be prepared urgently and schools should get enough financial support to supply the modules.

5.3. Implications for Future Research

This study aims to determine whether the innovative IT program is operating properly in vocational high schools in urban district of Ankara. The data was gathered from vocational high schools IT teachers and 11th grade IT area students.

Further studies would focus on assessment of graduates as a product evaluation effort in real work environment in order to improve the success of the program. Employers and representatives of work organizations should be included in these evaluations as well as the graduates.

Furthermore, further evaluations should be performed in a countrywide context to capture the implementation differences among urban and rural school district and among regions as well.

REFERENCES

- Akkoyunlu, B. (2002). Educational Technology in Turkey: Past, Present and Future [Electronic Version]. *Educational Media International*, 39, 165 - 174 from <http://www.informaworld.com/10.1080/09523980210155352>
- Akpınar, A. (2004). *Initial Vocational Education And Training In Turkey*. Ankara: Turkish National Observatory.
- Akpınar, A., & Ercan, H. (2002). Report on the Vocational Education and Training System in Turkey [Electronic Version] from www.iskur.gov.tr.
- Alkan, C., Doğan, H., & Sezgin, İ. (2001). *Mesleki ve Teknik Eğitimin Esasları* (1 ed.). Ankara: Nobel Yayın Dağıtım.
- Ashton, D. N., & Green, F. (1996). *Education, training and the global economy*: Edward Elgar.
- Baker, R. L. (1969). Curriculum Evaluation. *Review of Educational Research*, 39(3), 339.
- Başaran, İ. E. (1999). Türkiye'de Eğitim Sisteminin Evrimi. In F. Gök (Ed.), *75 Yılda Eğitim* (pp. 91-110). İstanbul: Tarih Vakfı
- Benavot, A. (1983). The Rise and Decline of Vocational Education. *Sociology of Education*, 56(2), 63-76.
- Biemans, H., Nieuwenhuis, L., Poell, R., Mulder, M., & Wesselink, R. (2004). Competence-based VET in the Netherlands: background and pitfalls. *Journal of Vocational Education & Training*, 56(4), 523-538.
- Bragg, D. D. (2001). Opportunities and challenges for the new vocationalism in American community colleges. *New Directions for Community Colleges*, 2001(115), 5.
- Cornford, I. (1997). Ensuring effective learning from modular courses: a cognitive. *Journal of Vocational Education and Training*, 49(2), 237-251.

- De Bruijn, E. (1995). Modular Vocational Education and Training in Scotland and The Netherlands: between specificity and coherence. *Comparative Education*, 31(1), 83-100.
- Dirkx, J. M., Kielbaso, G., & Corley, C. (1999). *A Study Of Vocational Education Programs In The Michigan Department Of Corrections* Michigan Center for Career and Technical Education, Department of Educational Administration.
- Düzcükoğlu, H., Asiltürk, İ., & Yaşar, M. (2005). *Project for Modernisation of Vocational and Technical Education and Evaluation of the Modular Education System*. Paper presented at the International Conference on Future Challenges for Development in Turkey within the Perspective of the Copenhagen Process and Maastricht Communiqué, Ankara.
- Erozan, F. (2005). Evaluating The Language Improvement Courses In The Undergraduate Elt Curriculum At Eastern Mediterranean University: A Case Study. Ankara: METU.
- Eşme, İ. (2007). *Türkiye'de Mesleki ve Teknik Eğitimin Bugünkü Durumu ve Sorunları*. Paper presented at the Uluslararası Mesleki ve Teknik Eğitim Konferansı, Ankara.
- ETF. (1999). An Overview of Vocational Education and Training in Turkey [Electronic Version] from <http://www.etf.eu.int/etfweb.nsf/pages/downloadturkey>.
- Finch, C. R., & Crunkilton, J. R. (1989). Curriculum Development in Vocational and Technical Education. Planning, Content, and Implementation.
- Finch, C. R., & Crunkilton, J. R. (1999). Curriculum Development in Vocational and Technical Education. Planning, Content, and Implementation.
- Fitz-Gibbon, C. T., & Morris, L. L. (1987). *How to Design a Program Evaluation*: Sage Publications.
- Glass, G. V. (1968). *Comments on Professor Bloom Entitled "Toward a Theory of Testing Which Includes Measurement-Evaluation-Assessment"*. California Univ., Los Angeles. Center for the Study of Evaluation.

- Gredler, M. E. (1996). *Program evaluation*: Merrill Englewood Cliffs, NJ.
- Grubb, W. N. (1985). The Convergence of Educational Systems and the Role of Vocationalism. *Comparative Education Review*, 29(4), 526-548.
- Grubb, W. N., Badway, N., Bell, D., Bragg, D., & Russman, M. (1997). Workforce, Economic, and Community Development. The Changing Landscape of the Entrepreneurial Community College.
- Güney, İ., & Oğuz, Y. (2002, 2002). *Mesleki ve Teknik Eğitime Öğretmen Yetiştirme*. Paper presented at the Eğitim Sorunları Kurultayı-II Mesleki ve Teknik Eğitim, İstanbul.
- Gürbüz, R., & Balcı, S. (1997). *Vocational and Technical Education Projects in Turkey*. Paper presented at the IVETA Conference, Helsinki, FINLAND.
- Hamilton, D. (1977). Making Sense of Curriculum Evaluation: Continuities and Discontinuities in an Educational Idea. *Review of Research in Education*, 5(1), 318.
- Herschbach, D. R. (1992). Technology and efficiency: Competencies as content. *Journal of Technology Education*, 3(2), 17-28.
- Horng, J.-S. (2004). Curriculum analysis of foods and beverage management of technological and vocational education in Taiwan. *Asia Pacific Journal of Tourism Research*, 9(2), 107-119.
- Lauglo, J., & Lillis, K. (1988). *Vocationalizing Education: An International Perspective* (First ed.): Pergamon Press.
- March, C. J., & Willis, G. (1999). Curriculum: Alternative Approaches. *Ongoing Issues, Columbus, Ohio, Merrill*.
- McAlister, M. T. (2006). *A Preliminary Study Of Faculty And Graduates Perceptions of Vocational Evaluation Competencies In The Educational Curriculum*. The Graduate Faculty of Auburn University, Auburn, Alabama.
- MEB. (1986). Milli Eğitim Bakanlığı Çıraklık ve Mesleki Eğitim Kanunu.

- MEB. (1999). XVI. Millî Eğitim Şûrası [Electronic Version] from http://ttkb.meb.gov.tr/secmeler/sura/16_sura.pdf.
- MEB. (2001). Milli Eğitim Bakanlığı Yükseköğretim Kanunu, Çıraklık Ve Meslek Eğitimi Kanunu, İlköğretim Ve Eğitim Kanunu, Millî Eğitim Temel Kanunu, Çıraklık Ve Meslek Eğitimi Kanunu, Millî Eğitim Bakanlığının Teşkilat Ve Görevleri Hakkında Kanun İle 24.3.1988 Tarihli Ve 3418 Sayılı Kanunda Değişiklik Yapılması Ve Bazı Kağıt Ve İşlemlerden Eğitime Katkı Payı Alınması Hakkında Kanun İle Millî Eğitim Bakanlığının Teşkilât Ve Görevleri Hakkında Kanunda Değişiklik Yapılmasına Dair Kanun.
- MEB. (2002). Milli Eğitim Bakanlığı Mesleki ve Teknik Eğitim Yönetmeliği.
- MEB. (2004). Milli Eğitim Bakanlığı Orta Öğretim Kurumları Sınıf Geçme ve Sınav Yönetmeliği.
- MEB. (2006a). Turkish National Education Council Draft Document (Preliminary committee reports) [Electronic Version] from <http://ttkb.meb.gov.tr/duyurular/17sura/sura.htm>.
- MEB. (2006b). XVII. Millî Eğitim Şûrası [Electronic Version] from http://ttkb.meb.gov.tr/secmeler/sura/17_sura.pdf.
- MEB. (2007a). National Education Statistics Formal Education 2006-2007 [Electronic Version] from http://sgb.meb.gov.tr/istatistik/meb_istatistikleri_orgun_egitim_2006_2007.pdf
- MEB. (2007b). T.C. Millî Eğitim Bakanlığı. 2007, from <http://www.meb.gov.tr>
- MEB-MEGEP. (2003a). National Qualification System :Purposes and Scope of an NQS [Electronic Version] from <http://www.megep.meb.gov.tr/indextr.html>.
- MEB-MEGEP. (2003b). National Qualification System: Governance and Management of the NQS [Electronic Version] from <http://www.megep.meb.gov.tr/indextr.html>.
- MEB-MEGEP. (2003c). Principles of Curriculum Development for VET

- [Electronic Version] from <http://www.megep.meb.gov.tr/indextr.html>.
- MEB-MEGEP. (2003d). SVET Final Inception Report [Electronic Version] from <http://www.megep.meb.gov.tr/indextr.html>.
- MEB-MEGEP. (2003e). Terms of Reference. Modified Following Clarification Meeting on 30 April 2002 [Electronic Version]. *SVET Final Inception Report* from <http://www.megep.meb.gov.tr/indextr.html>.
- MEB-MEGEP. (2005). *Modüler Bir Sistem.* from <http://www.megep.meb.gov.tr/indextr.html>.
- MEB-MEGEP. (2006). Turkey's Labour Market :A description of the developments from 1990 onwards [Electronic Version] from <http://svet.meb.gov.tr/indexen.html>.
- MEB-MEGEP. (2007a). Bilişim Teknolojileri Alanı Çerçeve Öğretim Programı [Electronic Version] from <http://www.megep.meb.gov.tr/indextr.html>.
- MEB-MEGEP. (2007b). Mesleki Eğitim Ve Öğretim Sisteminin Güçlendirilmesi Projesi (Megep) Kapsamında Yürütülen Çalışmalar [Electronic Version] from <http://www.megep.meb.gov.tr/indextr.html>.
- Middleton, J., Ziderman, A., & Van Adams, A. (1993). *Skills for Productivity: Vocational Education and Training in Developing Countries*: Oxford University Press US.
- Moodie, G. (2002). Identifying vocational education and training. *Journal of Vocational Education and Training*, 54(2), 249-266.
- Mulcahy, D. (2000). Body matters in vocational education: the case of the competently trained. *International Journal of Lifelong Education*, 19(6), 506-524.
- Mulder, M. (2007). The concept of competence in the development of vocational education and training in selected EU member states: a critical analysis. *Journal of Vocational Education & Training*, 59(1), 67-88.
- OECD. (1992). *High-Quality Education And Training For All*

. Paris.

Ogawa, K., & Tansel, A. (2005). Transition from Education to the Labor Market [Electronic Version]. *Turkey-Education Sector Study, Sustainable Pathways to an Effective, Equitable, and Efficient Education System for Preschool through Secondary School Education*, 131-138 from http://siteresources.worldbank.org/INTTURKEY/Resources/3616161142415001082/ESS_Main_Report_V1.pdf.

Olkun, S. (1995). *A Qualitative Assessment of School-To-Work Transition From The Perspective of Graduates and Employers: A Case Study of Balgat Industrial Vocational and Technical Lycee*. The Middle East Technical University, Ankara.

Ornstein, A. C., & Hunkins, F. P. (1998). *Curriculum: foundations, principles, and issues*. Boston: Allyn and Bacon.

Psacharopoulos, G. (1997). Vocational Education and Training Today: challenges and responses. *Journal of Vocational Education and Training*, 49(3), 385-393.

Salah, A. A.-A. (2002, 7-10 July). *An assessment of the vocational curriculum, Department of Production Engineering, College of Technological Studies, Kuwait*. Paper presented at the Australian Society for Educational Technology Conference, Melbourne.

Saylor, J. G., Alexander, W. M., & Lewis, A. (1981). *Curriculum planning for better teaching and learning*. Holt, Rinehart & Winston, New York.

Sezgin, İ. (1987). Yeni Mesleki-Teknik Eğitim Sistemi ve Okul-Endüstri İlişkileri. *Hacettepe Üniversitesi Eğitim Fakültesi Dergisi*, 2, 210-228.

Sezgin, İ. (2000). *Mesleki ve Teknik Eğitimde Program Geliştirme*. Ankara: Nobel Yayın Dağıtım.

Simsek, H., & Yildirim, A. (2000). Vocational Schools in Turkey: An Administrative and Organizational Analysis. *Revue Internationale de l'Education*, 46(3/4), 327-342.

Skilbeck, M. (1994). *The Vocational Quest: New Directions in Education and*

Training: Routledge.

Spector, J. M., Klein, J. D., Reiser, R. A., Sims, R. C., & Knowledgecraft, A. (2006). *Competencies and Standards for Instructional Design and Educational Technology*. Paper presented at the ITFORUM.

Stufflebeam, D. L. (2000). The CIPP model for evaluation. *Evaluation models: Viewpoints on educational and human services evaluation*, 2, 279-317.

Şimşek, M., & Gök, İ. (2005). *Policy and Strategies in Vocational and Technical Education*. Paper presented at the International Conference on Future Challenges for Development in Turkey within the Perspective of the Copenhagen Process and Maastricht Communique, Ankara.

Şirin, Ö. (2005). Mesleki ve Teknik Eğitimde uygulanan METGE projesi öğretim programları.

Tanner, D., & Tanner, L. N. (1975). *Curriculum development: theory into practice*: New York: Macmillan.

TBMM. (2006). Dokuzuncu Kalkınma Planı (2007 – 2013) [Electronic Version], 26215 from <http://ekutup.dpt.gov.tr/plan/ix/9kalkinmaplani.pdf>.

Thurow, L. C. (1999). *Building Wealth: The New Rules For Individuals, Companies and Nations In A Knowledge-Based Economy*: HarperCollins Publishers.

Topçu, T. (2005). An Investigation Of The Effectiveness Of The Theme-Based Curriculum In The 2003-2004 Academic Year At The Department Of Basic English At Middle East Technical University. Ankara: Metu.

Tunali, I. (2005). *General vs. Vocational Secondary School Choice and Labor Market Outcomes in Turkey, 1988-1998*: Mimeo.

UNESCO. (2003). Developing and Using Indicators of ICT Use in Education. Retrieved December 06, 2008, from from http://www2.unescobkk.org/education/ict/v2_2/info.asp?id=13253

Unluhisarcikli, O. (2005). Vocational Training through the Apprenticeship System

in Turkey.

Westbury, I. (1970). Curriculum Evaluation. *Review of Educational Research*, 40(2), 239.

Wikipedia 29.02.2009, from [http://en.wikipedia.org/wiki/Flexibility_\(engineering\)](http://en.wikipedia.org/wiki/Flexibility_(engineering))

Yalçın, O., Yıldırım, O., Altın, R., & Borat, O. (2005). *New Trends in Education Sector: Competences, Qualifications, Reference Levels and Learning Outcomes*. Paper presented at the International Conference on Future Challenges for Development in Turkey within the Perspective of the Copenhagen Process and Maastricht Communiqué, Ankara.

Yıldırım, A., & Simsek, H. (2001). A Qualitative Assessment Of The Curriculum Development Process At Secondary Vocational Schools In Turkey. *Journal of Career and Technical Education*, 19-31.

Yıldırım, O., Altın, R., & Yalçın, O. (2005). *Vocational and Technical Education and Training Program, Some Basic Principles Related to Its Learning and Management Elements*. Paper presented at the International Conference on Future Challenges for Development in Turkey within the Perspective of the Copenhagen Process and Maastricht Communiqué, Ankara.

YÖK. (2005). Diploma Eki Uygulaması Hakkında Güncel Bilgi [Electronic Version] from <http://www.yok.gov.tr/egitim/ab/DiplomaEki.doc>.

Zideman, A. (1997). National Programmes in Technical and Vocational Education: economic and education relationships 1. *Journal of Vocational Education and Training*, 49(3), 351-366.

APPENDICES

Appendix A: Framework IT program for Vocational High Schools

DERS KATEGORİLERİ		DERSLER	IX.	X.	XI.	
ORTAK DERSLER		*DİL VE ANLATIM	2	2	2	2
		TÜRK EDEBİYATI	3	3	-	-
		DİN KÜLTÜRÜ VE AHLAK BİLGİSİ	1	1	1	1
		TARİH	2	2	-	-
		T.C. İNKILAP TARİHİ VE ATATÜRKÇÜLÜK	-	-	2	-
		COĞRAFYA	2	2	-	-
		MATEMATİK	4	-		
		FİZİK	2	-		
		KİMYA	2	-		
		BİYOLOJİ	2	-		
		SAĞLIK BİLGİSİ	2	-	-	-
		FELSEFE	-	-	2	-
		YABANCI DİL	3	3		
		BEDEN EĞİTİMİ	2	-	-	-
		MİLLİ GÜVENLİK BİLGİSİ	-	1	-	-
		TRAFİK VE İLK YARDIM	-	-	1	-
		TANITIM VE YÖNLENDİRME	2	-	-	-
	TOPLAM	29	14	8	3	
ALAN / DAL DERSLERİ	ALAN ORTAK DERSLERİ	BİLGİ VE İLETİŞİM TEKNOLOJİSİ	2			
		MATEMATİK		3		
		MESLEKİ GELİŞİM		2		
		*BİLİŞİM TEKNOLOJİLERİNİN TEMELLERİ		8		
		PAKET PROGRAMLAR		2		
		TEMEL ELEKTRONİK VE ÖLÇME		3		
		TEKNİK VE MESLEK RESİM		2		
	DAL DERSLERİ	*İŞLETMELERDE BECERİ EĞİTİMİ				
		AĞ TEMELLERİ				
		VERİ TABANI				
		AĞ VERİ TABANI				
		*GÖRSEL PROGRAMLAMA				
		*NESNE TABANLI PROGRAMLAMA				
		ELEKTRONİK UYGULAMALARI				
		*SİSTEM BAKIM VE ONARIM				
		ENDÜSTRİYEL KONTROL				
		*MİKRODENETLEYİCİLER	-	-	24	29
		BİLGİSAYARLI DEVRE TASARIMI				
		GRAFİK VE ANİMASYON				
		*WEB TASARIMI VE PROGRAMLAMA				
		*İNTERNET PROGRAMCILIĞI				
		İŞLETİM SİSTEMLERİ (Açık Kaynak)				
		*AĞ SİSTEMLERİ VE YÖNLENDİRME				
		AĞ GÜVENLİĞİ				
		*SUNUCU İŞLETİM SİSTEMİ				
		AĞ DEĞİŞİM SUNUCU				
	ALAN/DAL DERSLERİ TOPLAMI		2	20	24	29
SEÇMELİ DERSLER		3	-	2	2	
REHBERLİK		1	1	1	1	
GENEL TOPLAM		35	35	35	35	

Not: (*) Millî Eğitim Bakanlığı Orta Öğretim Kurumları Sınıf Geçme ve Sınav Yönetmeliği'nin 33. maddesi uyarınca yıl sonu başarı ortalaması ile başarılı sayılmayacak dersleri ifade eder.

Appendix B: Framework IT program for Anatolian Vocational High Schools

DERS KATEGORİLERİ		DERSLER	IX.	X.	XI.	XII
ORTAK DERSLER		*DİL VE ANLATIM	2	2	2	2
		TÜRK EDEBİYATI	3	3	-	-
		DİN KÜLTÜRÜ VE AHLAK BİLGİSİ	1	1	1	1
		TARİH	2	2	-	-
		T.C. İNKILAP TARİHİ VE ATATÜRKÇÜLÜK	-	-	2	-
		COĞRAFYA	2	2	-	-
		MATEMATİK	4	-		
		FİZİK	2	-		
		KİMYA	2	-		
		BİYOLOJİ	2	-		
		SAĞLIK BİLGİSİ	2	-	-	-
		FELSEFE	-	-	2	-
		YABANCI DİL	10	4	4	4
		BEDEN EĞİTİMİ	2	-	-	-
		MİLLİ GÜVENLİK BİLGİSİ	-	1	-	-
		TRAFİK VE İLK YARDIM	-	-	1	-
		TOPLAM	34	15	12	7
ALAN / DAL DERSLERİ	ALAN ORTAK DERSLERİ	BİLGİ VE İLETİŞİM TEKNOLOJİSİ	2			
		MATEMATİK		3		
		MESLEKİ GELİŞİM		2		
		*BİLİŞİM TEKNOLOJİLERİNİN TEMELLERİ		9		
		PAKET PROGRAMLAR		2		
		TEMEL ELEKTRONİK VE ÖLÇME		3		
		TEKNİK VE MESLEK RESİM		2		
	DAL DERSLERİ	*İŞLETMELERDE BECERİ EĞİTİMİ				
		AĞ TEMELLERİ				
		VERİ TABANI				
		AĞ VERİ TABANI				
		*GÖRSEL PROGRAMLAMA				
		*NESNE TABANLI PROGRAMLAMA				
		ELEKTRONİK UYGULAMALARI				
		*SİSTEM BAKIM VE ONARIM				
		ENDÜSTRİYEL KONTROL				
		*MİKRODENETLEYİCİLER	-	-	27	30
		BİLGİSAYARLI DEVRE TASARIMI				
		GRAFİK VE ANİMASYON				
		*WEB TASARIMI VE PROGRAMLAMA				
		*İNTERNET PROGRAMCILIĞI				
		İŞLETİM SİSTEMLERİ (Açık Kaynak)				
		*AĞ SİSTEMLERİ VE YÖNLENDİRME				
		AĞ GÜVENLİĞİ				
	*SUNUCU İŞLETİM SİSTEMİ					
	AĞ DEĞİŞİM SUNUCU					
	ALAN/DAL DERSLERİ TOPLAMI			2	21	27
SEÇMELİ DERSLER			3	3	-	2
REHBERLİK			1	1	1	1
GENEL TOPLAM			40	40	40	40

Not: (*) Millî Eğitim Bakanlığı Orta Öğretim Kurumları Sınıf Geçme ve Sınav Yönetmeliği'nin 33. maddesi uyarınca yıl sonu başarı ortalaması ile başarılı sayılmayacak dersleri ifade eder.

Appendix C : Framework IT program for Technical High Schools

DERS KATEGORİLERİ	DERSLER	IX	X	XI.	XII.	
ORTAK DERSLER	*DİL VE ANLATIM	2	2	2	2	
	TÜRK EDEBİYATI	3	3	3	3	
	DİN KÜLTÜRÜ VE AHLAK BİLGİSİ	1	1	1	1	
	TARİH	2	2	-	-	
	T.C. İNKILAP TARİHİ VE ATATÜRKÇÜLÜK	-	-	2	-	
	COĞRAFYA	2	2	-	-	
	MATEMATİK	4	-	-	-	
	FİZİK	2	-	-	-	
	KİMYA	2	-	-	-	
	BİYOLOJİ	2	-	-	-	
	SAĞLIK BİLGİSİ	2	-	-	-	
	FELSEFE	-	-	2	-	
	YABANCI DİL	3	3	-	-	
	BEDEN EĞİTİMİ	2	-	-	-	
	MİLLİ GÜVENLİK BİLGİSİ	-	1	-	-	
	TRAFİK VE İLK YARDIM	-	-	1	-	
	TANITIM VE YÖNLENDİRME	2	-	-	-	
TOPLAM		29	14	11	6	
ALAN / DAL DERSLERİ	ALAN ORTAK DERSLERİ	BİLGİ VE İLETİŞİM TEKNOLOJİSİ	2			
		MATEMATİK	-	4	4	4
		GEOMETRİ	-	2	2	2
		ANALİTİK GEOMETRİ	-	-	-	2
		FİZİK	-	2	3	3
		KİMYA	-	2	3	3
		BİYOLOJİ	-	2	3	3
		MESLEKİ GELİŞİM		2		
		*BİLİŞİM TEKNOLOJİLERİNİN TEMELLERİ		9		
		PAKET PROGRAMLAR		2		
		TEMEL ELEKTRONİK VE ÖLÇME		3		
		TEKNİK VE MESLEK REŞİM		2		
	DAL DERSLERİ	İŞLETMELERDE BECERİ EĞİTİMİ				
		AĞ TEMELLERİ				
		VERİ TABANI				
		AĞ VERİ TABANI				
		*GÖRSEL PROGRAMLAMA				
		*NESNE TABANLI PROGRAMLAMA				
		ELEKTRONİK UYGULAMALARI				
		*SİSTEM BAKIM VE ONARIM				
		ENDÜSTRİYEL KONTROL				
*MİKRODENETLEYİCİLER		-	-	18	21	
BİLGİSAYARLI DEVRE TASARIMI						
GRAFİK VE ANİMASYON						
*WEB TASARIMI VE PROGRAMLAMA						
*İNTERNET PROGRAMCILIĞI						
İŞLETİM SİSTEMLERİ (Açık Kaynak)						
*AĞ SİSTEMLERİ VE YÖNLENDİRME						
AĞ GÜVENLİĞİ						
*SUNUCU İŞLETİM SİSTEMİ						
AĞ DEĞİŞİM SUNUCU						
ALAN/DAL DERSLERİ TOPLAMI		2	30	33	38	
SEÇMELİ DERSLER		3	-	-	-	
REHBERLİK		1	1	1	1	
GENEL TOPLAM		35	45	45	45	

Not: (*) Millî Eğitim Bakanlığı Orta Öğretim Kurumları Sınıf Geçme ve Sınav Yönetmeliği'nin 33. maddesi uyarınca yıl sonu başarı ortalaması ile başarılı sayılmayacak dersleri ifade eder.

Appendix D : Framework IT program for Anatolian Technical High Schools

DERS KATEGORİLERİ		DERSLER	IX.	X.	XI.	XII.	
ORTAK DERSLER		*DİL VE ANLATIM	2	2	2	2	
		TÜRK EDEBİYATI	3	3	3	3	
		DİN KÜLTÜRÜ VE AHLAK BİLGİSİ	1	1	1	1	
		TARİH	2	2	-	-	
		T.C. İNKILAP TARİHİ VE ATATÜRKÇÜLÜK	-	-	2	-	
		COĞRAFYA	2	2	-	-	
		MATEMATİK	4	-			
		FİZİK	2	-			
		KİMYA	2	-			
		BIYOLOJİ	2	-			
		SAĞLIK BİLGİSİ	2	-	-	-	
		FELSEFE	-	-	2	-	
		YABANCI DİL	10	4	4	4	
		BEDEN EĞİTİMİ	2	-	-	-	
		MİLLİ GÜVENLİK BİLGİSİ	-	1	-	-	
		TRAFİK VE İLK YARDIM	-	-	1	-	
	TOPLAM		34	15	15	10	
ALAN / DAL DERSLERİ	ALAN ORTAK DERSLERİ	BİLGİ VE İLETİŞİM TEKNOLOJİSİ	2				
		MATEMATİK	-	4	4	4	
		GEOMETRİ	-	2	2	2	
		ANALİTİK GEOMETRİ	-	-	-	2	
		FİZİK	-	2	3	3	
		KİMYA	-	2	3	3	
		BIYOLOJİ	-	2	3	3	
		MESLEKİ GELİŞİM		2			
		*BİLİŞİM TEKNOLOJİLERİNİN TEMELLERİ		8			
		PAKET PROGRAMLAR		2			
		TEMEL ELEKTRONİK VE ÖLÇME		3			
		TEKNİK VE MESLEK RESİM		2			
		DAL DERSLERİ	İŞLETMELERDE BECERİ EĞİTİMİ				
			AĞ TEMELLERİ				
	VERİ TABANI						
	AĞ VERİ TABANI						
	*GÖRSEL PROGRAMLAMA						
	*NESNE TABANLI PROGRAMLAMA						
	ELEKTRONİK UYGULAMALARI						
	*SİSTEM BAKIM VE ONARIM						
	ENDÜSTRİYEL KONTROL						
	*MİKRODENETLEYİCİLER		-	-	14	17	
	BİLGİSAYARLI DEVRE TASARIMI						
	GRAFİK VE ANİMASYON						
	*WEB TASARIMI VE PROGRAMLAMA						
	*İNTERNET PROGRAMCILIĞI						
	İŞLETİM SİSTEMLERİ (Açık Kaynak)						
*AĞ SİSTEMLERİ VE YÖNLENDİRME							
AĞ GÜVENLİĞİ							
*SUNUCU İŞLETİM SİSTEMİ							
AĞ DEĞİŞİM SUNUCU							
ALAN/DAL DERSLERİ TOPLAMI			2	29	29	34	
SEÇMELİ DERSLER			3		-		
REHBERLİK			1	1	1	1	
GENEL TOPLAM			40	45	45	45	

Not: () Millî Eğitim Bakanlığı Orta Öğretim Kurumları Sınıf Geçme ve Sınav Yönetmeliği'nin 33. maddesi uyarınca yıl sonu başarı ortalaması ile başarılı sayılmayacak dersleri ifade eder.*

Appendix E : Training Standard of Computer Technical Service

EĞİTİM STANDARDI		KOD
EĞİTİM ALANI	HESAP	48
ÖĞRETİM ALANI	BİLGİSAYAR BİLİMİ VE	481
	BİLGİSAYAR KULLANIMI	482
ÖĞRETİM PROGRAMI	BİLİŞİM TEKNOLOJİLERİ	481BB-482BK
MESLEK/DAL	BİLGİSAYAR TEKNİK SERVİSİ	
SEVİYESİ:	4	
TANIM	Bilgisayar sistemlerinin donanım ve yazılımı kurulumu, bakım ve arıza giderme işlemleri ve bilgisayar ile kontrol edilebilen sistemleri kurma yeterliklerini kazandırmaya yönelik eğitim ve öğretimdir.	
GİRİŞ KOŞULLARI	Temel Eğitimi tamamlamış olmak Mesleğe engel hali bulunmamak	
ÖLÇME VE DEĞERLENDİRME	Eğitim kurumlarının özelliğine göre ilgili mevzuat (yasa, tüzük, yönetmelik ve genelgeler) doğrultusunda kazanılan yeterlikler ölçülerek sonuçlar değerlendirilecektir.	
SÜRE VE DEĞERLENDİRME	4 yıllık mesleki programın sonunda diploma verilir. Sertifika eğitimi (en az 2500 saat)sonunda; 4. seviye sertifikaya yönelik eğitim belgesi verilir.	
AÇIKLAMALAR	Eğitim sonunda verilen tüm belgeler, yeterlilik sınavında ve üst öğrenimde değerlendirilir	
GÖREVLER	İş Organizasyonu yapmak Bilgisayarla Devre Çizimi Yapmak Bilgisayarın Periyodik Bakımını Yapmak Bilgisayarın Arızasını Gidermek Sayısal elektronik ve elektronik uygulamaları yapmak Endüstriyel kontrol uygulamaları yapmak Lehimleme uygulamaları yapmak Mikrodenetleyici kullanarak kontrol yapmak Mesleki Gelişime İlişkin Faaliyetleri Yürütmek	
SONUÇ ÜRÜN-HİZMET)	Bilgisayar sistemlerinin donanım ve yazılımı kurulumu, arıza giderme ve kontrol sistemleri devreleri yapmak	
İSTİHDAM ALANLARI (İŞ YERİ VE ÇALIŞMA KOŞULLARI)	Teknik Servis Elemanları, bilgisayar toplama ve satış işlemi yapan firmalarda, bünyesinde bilgisayar bulunduran iş yerleri, şirketlerde, özel sektöre ait firmalarda çalışabilirler. Ayrıca kendilerine ait özel iş yerleri de açabilirler. Bilgisayar Teknik Servis Elemanı, teknik servis (bilgisayar toplanan) ortamında, Elektronik devre yapımını gerçekleştirebileceği atölye ortamında, çalışır.	

YETERLİKLER	<p>Ağ tasarımı yapmak Bakır ortam bağlantılarını yapmak LAN kablolama yapmak TCP/IP protokolünü kullanmak Sistem koruma yazılımlarını kullanmak Lehim yapmak SMD montajı ve demontajı yapmak Güç kaynağı yapmak SMPS güç kaynağı yapmak Tümleşik devreleri çalıştırmak Aritmetik devreler ile çalışma yapmak Flip - floplar ile çalışma yapmak Sayıcılar ile çalışma yapmak Kaydediciler ile çalışma yapmak Transistörler ile çalışma yapmak Opamplar ile çalışma yapmak Osilatörlerle çalışma yapmak Modülasyon uygulamaları yapmak Bakım yapmak Kurulum yapmak Sorun gidermek Yazılım sorunlarını gidermek İşletim sistemleri sorunlarını gidermek Ağ sorunlarını gidermek Linux sorunlarını gidermek Röle uygulamaları yapmak Transistör uygulamaları yapmak Sensör uygulamaları yapma Dönüştürme uygulamaları yapmak Motor uygulamaları yapmak Montaj yapmak Dijital işlemler yapmak Çevrim kontrolleri yapmak Elektrik elektronik devre ve şemalarını, bilgisayar ortamında çizerek simülasyonunu yapmak Elektrik elektronik devre ve şemalara ait baskı devreleri bilgisayar ortamında çizmek</p>
AÇIKLAMALAR	

Appendix F : Training Standard of Web Programming

EĞİTİM STANDARTI		KOD
EĞİTİM ALANI	HESAP	48
ÖĞRETİM ALANI	BİLGİSAYAR BİLİMİ VE	481
	BİLGİSAYAR KULLANIMI	482
ÖĞRETİM PROGRAMI	BİLİŞİM TEKNOLOJİLERİ	481BB-482BK
MESLEK/DAL	WEB PROGRAMCILIĞI	
SEVİYESİ:	4	
TANIM	Bilgisayar sistemlerinin donanım ve yazılım olarak kurulumu, web sayfası tasarımına ve programlama dilleri yardımıyla etkileşimli web uygulamaları hazırlama yeterliklerini kazandırmaya yönelik eğitim ve öğretimdir.	
GİRİŞ KOŞULLARI	Temel Eğitimini tamamlamış olmak Mesleğe engel hali bulunmamak	
ÖLÇME DEĞERLENDİRME VE	Eğitim kurumlarının özelliğine göre ilgili mevzuat (yasa, tüzük, yönetmelik ve genelgeler) doğrultusunda kazanılan yeterlikler ölçülerek sonuçlar değerlendirilecektir.	
SÜRE VE DEĞERLENDİRME	4 yıllık mesleki programın sonunda diploma verilir. Sertifika eğitimi (en az 2500 saat)sonunda; 4. seviye sertifikaya yönelik eğitim belgesi verilir.	
AÇIKLAMALAR	Eğitim sonunda verilen tüm belgeler, yeterlilik sınavında ve üst öğrenimde değerlendirilir	
GÖREVLER	İş Organizasyonu yapmak HTML ile Web Sayfası Hazırlamak Web sayfaları için resimler hazırlamak ve düzenlemek Web sayfaları için resimler hazırlamak ve düzenlemek Web sayfaları için animasyonlar hazırlamak ve düzenlemek Web sayfası hazırlama editörünü kullanmak Web ortamında çalışan programlar yazmak .NET Yazılımlarını Kullanarak Web Programları Hazırlamak Açık Kaynak Kodlu işletim sistemini kullanmak Mesleki Gelişime İlişkin Faaliyetleri Yürütmek	
SONUÇ ÜRÜN-HİZMET)	Bilgisayar sistemleri, web sayfası tasarımı ve programlama dilleri yardımıyla etkileşimli web uygulamaları hazırlamak.	
İSTİHDAM ALANLARI (İŞ YERİ VE ÇALIŞMA KOŞULLARI)	Web programcıları, kamu kuruluşları, bankalar ile özel sektöre ait iş yerleri, internet üzerinden ticaret (e-ticaret) yapan firmalarda çalışabilirler. Ayrıca kendilerine ait özel iş yerleri de açabilirler. Web programcısı, büro ortamında çalışır ve genellikle tasarım ve görsel unsurlarla uğraşır. Çalışırken diğer meslektaşlarıyla ve iş sahipleriyle etkileşim hâlinindedir. İş oturarak yürütülür, ortam genellikle sessizdir.	

YETERLİKLER	<p>Ağ tasarımı yapmak Bakır ortam bağlantılarını yapmak LAN kablolama yapmak TCP/IP protokolünü kullanmak Sistem koruma yazılımlarını kullanmak Web sayfaları için resimler hazırlamak Resimler ile web araçları hazırlamak Web sayfaları için animasyonlar hazırlamak Animasyonlar ile web araçları hazırlamak HTML kodları ile web sayfaları için basit işlemler yapmak HTML kodları ile web sayfaları için gelişmiş özellikler oluşturmak Web sayfaları içine resimler yerleştirmek ve bağlantılar oluşturmak Web sayfaları için tablo ve stiller oluşturmak Web sayfaları için çerçeveler oluşturmak Web sayfaları içine formlar yerleştirmek ve kullanıcı etkileşimli uygulamaları yapmak Programlama için gerekli yazılım kurulumlarını yapmak Programlama dilinin komut yapısını tanıyarak programlar içinde kullanmak Form uygulamaları yapmak Web servislerini kullanmak İnternet ortamında çalışan programlar hazırlamak için gerekli olan sunucu ve veri tabanı kurulumlarını yapmak Programlama dilinin komut yapısını tanıyarak temel programlama elemanlarını kullanmak Programlama içinde fonksiyon ve dizi işlemleri yapmak Programlama içinde form ve nesnelere kullanmak Hazırlanan programa ait veri tabanı işlemlerini yapmak Açık kaynak kodlu işletim sisteminin kurulumunu ve optimizasyonunu yapmak Açık kaynak kodlu işletim sisteminin ağ yönetimi birimlerini ayarlamak Açık kaynak kodlu işletim sisteminin ağ yönetimini gerçekleştirmek</p>
AÇIKLAMALAR	

Appendix G : Training Standard of Database Programming

EĞİTİM STANDARDI		KOD
EĞİTİM ALANI	HESAP	48
ÖĞRETİM ALANI	BİLGİSAYAR BİLİMİ VE BİLGİSAYAR KULLANIMI	481 482
ÖĞRETİM PROGRAMI	BİLİŞİM TEKNOLOJİLERİ	481BB-482BK
MESLEK/DAL	VERİ TABANI PROGRAMCILIĞI	
SEVİYESİ:	4	
TANIM	Bilgisayar sistemlerinin donanım ve yazılım kurulumu, veri tabanı ve programlama dilinin kurulumu, veri tabanının oluşturulması ve yönetimi, yazılım geliştirme, hata giderme, bakım ve yedek alma yeterliklerini kazandırmaya yönelik eğitim ve öğretimdir.	
GİRİŞ KOŞULLARI	Temel Eğitimi tamamlamış olmak Mesleğe engel hali bulunmamak	
ÖLÇME VE DEĞERLENDİRME	Eğitim kurumlarının özelliğine göre ilgili mevzuat (yasa, tüzük, yönetmelik ve genelgeler) doğrultusunda kazanılan yeterlikler ölçülerek sonuçlar değerlendirilecektir.	
SÜRE VE DEĞERLENDİRME	4 yıllık mesleki programın sonunda diploma verilir. Sertifika eğitimi (en az 2500 saat)sonunda; 4. seviye sertifikaya yönelik eğitim belgesi verilir.	
AÇIKLAMALAR	Eğitim sonunda verilen tüm belgeler, yeterlilik sınavında ve üst öğrenimde değerlendirilir	
GÖREVLER	İş Organizasyonu yapmak Veritabanı İşletimi yapmak Ağ veritabanı işletimi yapmak Görsel Programlama dili ile program yazmak Nesneye yönelik programlama dili ile program yazmak Mesleki Gelişime İlişkin Faaliyetleri Yürütmek	
SONUÇ ÜRÜN-HİZMET)	Bilgisayar sistemlerinin ve programlama dillerinin kurulumu ve yazılım geliştirmek.	
İSTİHDAM ALANLARI (İŞ YERİ VE ÇALIŞMA KOŞULLARI)	Veri Tabanı Programcıları, kamu kuruluşları, bankalar ile özel sektöre ait firmalarda çalışabilirler. Ayrıca kendilerine ait özel iş yerleri de açabilirler. Veri Tabanı programcısı, büro ortamında çalışır ve genellikle programlama ve görsel unsurlarla uğraşır. Çalışırken diğer meslektaşlarıyla ve iş sahipleriyle etkileşim hâlinindedir. İş oturarak yürütülür, ortam genellikle sessizdir.	

YETERLİKLER	<p>Ağ tasarımını yapmak Bakır ortam bağlantılarını yapmak LAN kablolama yapmak TCP/IP protokolünü kullanmak Sistem koruma yazılımlarını kullanmak Veri tabanı ihtiyaçlarını analiz etmek Veri tabanında tablo yapmak Veri tabanında sorgu yapmak Veri tabanında form ve rapor yapmak Veri tabanında makro yapmak Veri tabanında kaynak dosyalar ile çalışmak Veri tabanı güvenlik ayarlarını yapmak Ağ veri tabanı kurulumunu yapmak Veri tabanı planlamasını yapmak T-SQL kullanmak Veri bütünlüğünü sağlamak Veri tabanı yönetimini yapmak Veri tabanı ile ilgili yardımcı işlemleri yapmak Görsel programlama dilinin kurulumunu yapmak Görsel ara birim yapmak Görsel programlamada kod kısımlarını yazmak Görsel programlama dilinin komutlarını kullanmak Görsel programlama dilinde yardımcı komutları yazmak Görsel programlama kod hatalarını gidermek Görsel programlama veri tabanı ile program yazmak Görsel programlama İnternet uygulamaları yapmak Programlama dilinin gerekliliklerini yerine getirmek Programlama dili ile ara yüz yapmak Programlama dilinde kod yazmak Programdaki hataları gidermek Programı yayımlamak Veri tabanı ile program yazmak</p>
AÇIKLAMALAR	

Appendix H : Training Standard of Network Management

EĞİTİM STANDARDI		KOD
EĞİTİM ALANI	HESAP	48
ÖĞRETİM ALANI	BİLGİSAYAR BİLİMİ VE BİLGİSAYAR KULLANIMI	481 482
ÖĞRETİM PROGRAMI	BİLİŞİM TEKNOLOJİLERİ	481BB-482BK
MESLEK/DAL	AĞ İŞLETMENLİĞİ	
SEVİYESİ:	4	
TANIM	Bilgisayar sistemlerinin donanım ve yazılım kurulumu, ağ sistemlerinin kurulumu, yönetimi ve ağ ortamı üzerinde yaşanabilecek sorunları tespit etme, çözüm yolları önerme ve geniş ağ sistemleri yönetimi yeterliklerini kazandırmaya yönelik eğitim ve öğretimdir.	
GİRİŞ KOŞULLARI	Temel Eğitimi tamamlamış olmak Mesleğe engel hali bulunmamak	
ÖLÇME DEĞERLENDİRME	VE	Eğitim kurumlarının özelliğine göre ilgili mevzuat (yasa, tüzük, yönetmelik ve genelgeler) doğrultusunda kazanılan yeterlikler ölçülerek sonuçlar değerlendirilecektir.
SÜRE VE DEĞERLENDİRME	4 yıllık mesleki programın sonunda diploma verilir. Sertifika eğitimi (en az 2500 saat)sonunda; 4. seviye sertifikaya yönelik eğitim belgesi verilir.	
AÇIKLAMALAR	Eğitim sonunda verilen tüm belgeler, yeterlilik sınavında ve üst örgenimde değerlendirilir	
GÖREVLER	İş Organizasyonu yapmak ,Ağ Kurulumu yapmak Yönlendirme ve Yapılandırma Yapmak (Yönlendirme Teknikleri) Yönlendiriciyi Kullanmak,Yönlendirme Sorunlarını Gidermek Gelişmiş Ağ Sunucu İşletim Sistemi Ortamını Kullanmak Gelişmiş Ağ Değişim (Exchange) Sunucu İşletim Sistemini Kullanmak Açık Kaynak Kodlu İşletim Sistemini Kullanmak Ağ Güvenliği ve Bakımı Mesleki Gelişime İlişkin Faaliyetleri Yürütmek	
SONUÇ ÜRÜN-HİZMET)	Bilgisayar sistemlerinin kurulumunu yapmak ve geniş ağ sistemleri yönetmek.	
İSTİHDAM ALANLARI (İŞ YERİ VE ÇALIŞMA KOŞULLARI)	Bilgisayar satış ve teknik destek firmaları, bankalar, sigorta şirketleri, ticarî kuruluşlar, internet servis sağlayıcıları, internet yayıncılık şirketleri, radyo- televizyon şirketleri, araştırma şirketleri, borsalar, ulaştırma, lojistik firmaları ve hizmet sektöründe yer alan kamu kurum ve kuruluşlarında geniş iş imkânına sahiptirler. Ayrıca kendi adlarına işyeri açabilirler. Endüstride ve işletmelerde bilgisayar kullanılacak iş ortamlarında çalışırlar. Ayrıca geniş ağ bağlantıları oluşturabilmek için dış ortamda, oluşturulan ağların yönetimi için sunucuların bulunduğu büro ortamlarında çalışırlar. Birinci derecede cihaz, alet ve yazılımlarla ilgilidirler. Ancak, zaman zaman meslektaşları ve müşterilerle iletişim kurmaları gerekir.	

YETERLİKLER	<p>Ağ tasarımı yapmak Bakır ortam bağlantılarını yapmak LAN kablolama yapmak TCP/IP protokolünü kullanmak Sistem koruma yazılımlarını kullanmak Fiber (optik) ağ bağlantılarını yapmak WAN elemanlarının bağlantılarını yapmak Kablosuz ortam bağlantılarını yapmak Ağ için uygun ethernet standardını belirlemek Temel yönlendirmeleri yapmak Alt ağ oluşturmak TCP/IP taşıma ve uygulama katmanını kullanmak Yönlendiriciyi sisteme bağlamak Yönlendiriciyi yapılandırmak Diğer aygıtları kullanmak Yönlendirici yazılımını kullanmak Yönlendirme şeklini belirlemek Uzaklık vektörü iletişim kuralı ile yönlendirme yapmak TCP/IP kontrol mesajları ile bağlantıyı test etmek Yönlendirici sorunlarını gidermek TCP/IP protokol uygulamalarını yapmak Erişim kontrol listelerini yönetmek Donanımsal ağ güvenliğini ve bakımını sağlamak Yazılımsal ağ güvenliğini ve bakımını sağlamak Gelişmiş ağ işletim sistemini kurmak Gelişmiş ağ sunucu işletim sisteminin kullanıcı ortamını sağlamak Gelişmiş ağ sunucu işletim sisteminin yazdırma ortamını sağlamak Gelişmiş ağ sunucu işletim sisteminin grup politikalarını sağlamak Gelişmiş ağ sunucu işletim sisteminin aktif rehberini tasarlamak Gelişmiş ağ sunucu işletim sisteminin ağ alt yapısını tasarlamak Gelişmiş ağ değişim (exchange) sunucu işletim sistemini kurmak Gelişmiş ağ değişim sunucu işletim sistemini yönetmek Gelişmiş ağ değişim (exchange) sunucu işletim sisteminin ağ unsurlarını yönetmek Gelişmiş ağ değişim (exchange) sunucu işletim sisteminde koruma ve yedekleme yapmak Gelişmiş ağ değişim (exchange) sunucu işletim sisteminde arıza bulmak ve çözmek Gelişmiş ağ değişim (exchange) sunucu işletim sisteminde ileri seviye arıza bulmak ve çözmek Açık Kaynak Kodlu İşletim Sisteminin Kurulumunu ve Optimizasyonunu Yapmak Açık Kaynak Kodlu İşletim Sisteminin ağ yönetimi birimlerini ayarlamak Açık Kaynak Kodlu İşletim Sisteminin ağ yönetimini gerçekleştirmek</p>
AÇIKLAMALAR	

Appendix I : Teachers Questionnaire (Turkish)

Meslek Liseleri Bilişim Teknolojileri Alan Programı Öğretmen Etki Değerlendirme Anketi

Sayın Öğretmenim,

Bu anket *yeni modüler bilişim teknolojileri öğretim programının* değerlendirmesini yapmak ve uygulamada etkili olan faktörleri tespit etmek amacıyla gerçekleştirilen akademik bir çalışmada kullanılmak üzere hazırlanmıştır. Soruları yanıtlarken göstereceğiniz dikkat, samimiyet ve sabır, var olan durumun olduğu gibi ortaya konulması açısından önemlidir. Bu nedenle lütfen formdaki hiçbir soruyu yanıtızsız bırakmayınız.

Yanıtlarınızın akademik amaçlarla kullanılacağı bu ankete isimlerinizi yazmanız gerekmemektedir. Katkılarınızdan ötürü teşekkür eder, çalışmalarınızda başarılar dileriz.

Kader BİÇER
ODTÜ Eğitim Fakültesi,
Eğitim Bilimleri Bölümü
Yüksek Lisans Öğrencisi

Doç. Dr. Ercan KİRAZ
ODTÜ Eğitim Fakültesi,
Eğitim Bilimleri Bölümü

Bölüm 1:

Kişisel Bilgiler

Bu bölümde kişisel bilgilerinize ilişkin sorular yer almaktadır.

1. Cinsiyetiniz: K E
2. Yaşınız : 20–25 26–30 31–35 36–40 41–45 46 veya daha fazla
3. Mezun olduğunuz Üniversite (yazınız)
4. Mezun olduğunuz Fakülte (yazınız)
5. Mezun olduğunuz Bölüm (yazınız)
6. Şu anda görev yaptığınız ilçe.....
7. Çalıştığınız okul türü
 Meslek Lisesi Anadolu Meslek Lisesi Teknik Lise Anadolu Teknik Lise
8. Çalıştığınız okul türünün bağlı olduğu Genel Müdürlük
 Erkek Teknik Öğretim Genel Müdürlüğü
 Kız Teknik Öğretim Genel Müdürlüğü
 Ticaret ve Turizm Öğretimi Genel Müdürlüğü
9. Hizmet yılınız
 1–5 6–10 11–15 16–20 21–24 25 veya daha fazla
10. Okulunuzda gerekli Bilişim Teknolojileri öğretmeni sayısı....., mevcut sayı
11. Öğretmen olarak statünüz nedir?
 Uzman Kadrolu Stajyer Sözleşmeli Ücretli
12. Bu dönem haftada toplam kaç saat derse giriyorsunuz?
13. Okulunuzda Bilişim Teknolojileri alanı altında eğitim verilen dallar hangileridir?
 Bilgisayar Teknik Servisi
 Veri Tabanı Programcılığı
 Web Programcılığı
 Ağ İşletmenliği
14. a) Şimdiye kadar yeni modüler bilişim teknolojileri programıyla ilgili kaç kez bir hizmet içi eğitim kursuna, çalışma ya da toplantıya katıldınız?
 Hiç katılmadım Bir kez İki kez İki'den fazla
b) Katıldıysanız bu hizmet içi eğitim kursu, çalışma ya da toplantı sizce ne derece yararlı oldu?

- Çok yararlı oldu Kısmen yararlı oldu Hiç yararlı olmadı
c)Bu kurs, çalışma ya da toplantının neden yararlı olduğunu ya da yararlı olmadığını düşünüyorsunuz? Lütfen açıklayınız?

Bölüm 2:

Yeni Programın İlkelerine İlişkin Görüşler

Bu bölümde yer alan ifadelerde görüşünüzü yuvarlak kutucukları doldurarak belirtebilirsiniz. (Lütfen her ifade için bir kutucuk doldurunuz)

İFADELER/GÖRÜŞLER	Kesinlikle	Katılıyorum	Kararsızım	Katılmıyorum	Kesinlikle
	Katılıyorum	Katılıyorum	Katılıyorum	Katılıyorum	Katılmıyorum
Öğretmenler					
1. Programın amaçları ve işleyişi hakkında yeterli bilgiye sahibim.	<input type="radio"/>	<input type="radio"/>	<input type="radio"/>	<input type="radio"/>	<input type="radio"/>
2. Programı tanıtıcı toplantı ve seminerler yeterlidir.	<input type="radio"/>	<input type="radio"/>	<input type="radio"/>	<input type="radio"/>	<input type="radio"/>
3. Program kolay uygulanabilirlik ve pratiklik açısından yeterlidir.	<input type="radio"/>	<input type="radio"/>	<input type="radio"/>	<input type="radio"/>	<input type="radio"/>
4. Programda yer alan derslerin içeriği konulara tam olarak hakimim.	<input type="radio"/>	<input type="radio"/>	<input type="radio"/>	<input type="radio"/>	<input type="radio"/>
5. Programda yer alan uygulama faaliyetlerine tam olarak hakimim.	<input type="radio"/>	<input type="radio"/>	<input type="radio"/>	<input type="radio"/>	<input type="radio"/>
6. Programda yer alan yeni dersler hakkında hizmet içi eğitime ihtiyacım var.	<input type="radio"/>	<input type="radio"/>	<input type="radio"/>	<input type="radio"/>	<input type="radio"/>
7. Program öğretmenler için ilave kaynak ve kılavuz kitap,araç-gereç vb. destekleri sağlıyor.	<input type="radio"/>	<input type="radio"/>	<input type="radio"/>	<input type="radio"/>	<input type="radio"/>
8. Programla ilgili problemlerimi okul içi toplantılarla çözebiliyorum.	<input type="radio"/>	<input type="radio"/>	<input type="radio"/>	<input type="radio"/>	<input type="radio"/>
9. Programın okulun sağladığı destekle çözülemeyecek problemleri var.	<input type="radio"/>	<input type="radio"/>	<input type="radio"/>	<input type="radio"/>	<input type="radio"/>
10. Program değişimi gerekliydi ve sonuçların olumlu olacağı kanısındayım.	<input type="radio"/>	<input type="radio"/>	<input type="radio"/>	<input type="radio"/>	<input type="radio"/>
Alan ve Dalların Amaçları					
11. Amaçlar bilişim sektöründeki küresel gelişmeler doğrultusunda hazırlanmıştır.	<input type="radio"/>	<input type="radio"/>	<input type="radio"/>	<input type="radio"/>	<input type="radio"/>
12. Amaçlar ülkemizin bilişim alandaki ilgi ve beklentileri dikkate alınarak hazırlanmıştır.	<input type="radio"/>	<input type="radio"/>	<input type="radio"/>	<input type="radio"/>	<input type="radio"/>
13. Amaçlar yerel sanayi ve işveren ihtiyaçlarına cevap verir niteliktedir.	<input type="radio"/>	<input type="radio"/>	<input type="radio"/>	<input type="radio"/>	<input type="radio"/>
14. Amaçlar toplumun ilgi ve ihtiyaçları dikkate alınarak hazırlanmıştır.	<input type="radio"/>	<input type="radio"/>	<input type="radio"/>	<input type="radio"/>	<input type="radio"/>
15. Bireyin ilgi ve ihtiyaçları doğrultusunda şekillendirilebilir yapıdadır.	<input type="radio"/>	<input type="radio"/>	<input type="radio"/>	<input type="radio"/>	<input type="radio"/>
16. Amaçlar mesleğin gerektirdiği becerileri tam olarak kapsamaktadır.	<input type="radio"/>	<input type="radio"/>	<input type="radio"/>	<input type="radio"/>	<input type="radio"/>
İçerik					
17. İçerik amaçları gerçekleştirebilecek niteliktedir.	<input type="radio"/>	<input type="radio"/>	<input type="radio"/>	<input type="radio"/>	<input type="radio"/>
18. Alanla ilgili tüm konulara içerikte yer verilmiştir.	<input type="radio"/>	<input type="radio"/>	<input type="radio"/>	<input type="radio"/>	<input type="radio"/>
19. İçerik okulumuzun yetiştirmeyi amaçladığı işgücünün sahip olması gereken becerileri kapsamaktadır.	<input type="radio"/>	<input type="radio"/>	<input type="radio"/>	<input type="radio"/>	<input type="radio"/>
20. İçerik öğrenci odaklı yaklaşım esas alınarak hazırlanmıştır.	<input type="radio"/>	<input type="radio"/>	<input type="radio"/>	<input type="radio"/>	<input type="radio"/>
21. 10.sınıf ders içerikleri alanın temel becerileri kazandırmada yeterlidir.	<input type="radio"/>	<input type="radio"/>	<input type="radio"/>	<input type="radio"/>	<input type="radio"/>

İFADELER/GÖRÜŞLER		Kesinlikle Katılıyorum	Katılıyorum	Kararsızım	Katılmıyorum	Kesinlikle Katılmıyorum
22.	Dallar bilişim sektöründeki meslekler doğrultusunda oluşturulmuştur.	0	0	0	0	0
23.	11 ve 12 sınıf ders içerikleri dallara özel becerileri kazandırmada yeterlidir.	0	0	0	0	0
24.	İyi ilişkiler kurabilmek, işe uyum sağlayabilmek gibi genel bilgi ve becerileri kazandıran derslerin içerikleri yeterlidir.	0	0	0	0	0
25.	Dersler içerisindeki modüller arası ilişkiler iyi yapılandırılmıştır.	0	0	0	0	0
26.	Modüller içeriğin sıralanışı bakımından birbirinin önkoşulu niteliğindedir.	0	0	0	0	0
Yeni Bilişim Teknolojileri Programı Öğretim Süreci						
27.	Dersler ve modül içerikleri teknolojik ve bilimsel gelişmelere paralel olarak güncellenebilir yapıdadır.	0	0	0	0	0
28.	Program bölgesel düzeydeki eğitim ihtiyaçlarına göre uyarlamalar bakımından esnekler.	0	0	0	0	0
29.	Program okulumuzun bulunduğu çevredeki yerel iş piyasasının ihtiyaçları analiz edilerek şekillendirilmiştir.	0	0	0	0	0
30.	Program okulumuzun bulunduğu çevredeki toplumun ihtiyaçları analiz edilerek şekillendirilmiştir.	0	0	0	0	0
31.	Program okulumuzda bulunan öğrencilerin ilgi, tercih ve ihtiyaçları analiz edilerek şekillendirilmiştir.	0	0	0	0	0
32.	Program okulumuzda bulunan öğrencilerin halihazırda sahip oldukları nitelikler analiz edilerek şekillendirilmiştir.	0	0	0	0	0
33.	Program okulumuzda bulunan her bir öğrencinin ilerleme hızı analiz edilerek şekillendirilmiştir.	0	0	0	0	0
34.	Program okulumuzda bulunan her bir öğrencinin geçmiş yaşantıları ve öğrenme yöntemleri analiz edilerek şekillendirilmiştir.	0	0	0	0	0
35.	Modül seçimi ve sürelerinin belirlenmesinde okulumuzun bulunduğu çevredeki işverenlerin ihtiyaçları etkili olmuştur.	0	0	0	0	0
36.	Modül seçimi ve sürelerinin belirlenmesinde okulumuzun öğretmen ve öğrenci nitelikleri etkili olmuştur.	0	0	0	0	0
37.	Modül seçimi ve sürelerinin belirlenmesinde okulumuzun altyapı ve kaynak durumu etkili olmuştur.	0	0	0	0	0
38.	Okulumuzda modül seçimi ve sürelerinin belirlenmesi için idareci, öğretmen ve sektör temsilcilerinden oluşan bir kurul oluşturulmuştur.	0	0	0	0	0
39.	Öğretim süreci sektörle işbirliği içinde yürütülmektedir.	0	0	0	0	0
40.	Öğretmenler sektörle sürekli iletişim içindedir.	0	0	0	0	0
41.	Öğrenciler sektörde alanıyla ilgili geniş staj imkanı bulabilmektedir.	0	0	0	0	0
42.	Sektörde yapılacak staj süresi öğrenciler için yeterlidir.	0	0	0	0	0
43.	Program öğrencilere dersler arasında seçim yaparak kendilerine ait bir yol izleme imkanı sunmaktadır.	0	0	0	0	0
44.	Program öğrencilere modüller arasında seçim yaparak kendilerine ait bir yol izleme imkanı sunmaktadır.	0	0	0	0	0
45.	Program öğrencilere seviyelerine uygun hızlarda ilerleme buna bağlı olarak değişik zamanlarda mezun olma imkanı sağlamaktadır.	0	0	0	0	0
46.	Program alanlar arası geçiş imkanı sunmaktadır.	0	0	0	0	0

İFADELER/GÖRÜŞLER		Kesinlikle Katılıyor	Katılıyor	Kararsız	Katılmıyor	Kesinlikle Katılmıyor
47.	Program dallar arası geçiş imkanı sunmaktadır.	0	0	0	0	0
48.	Program herhangi bir seviyede okuldan ayrılan öğrencilerin, başardıkları modüllere göre sertifika alabilmelerine imkan sağlamaktadır.	0	0	0	0	0
49.	Program herhangi bir seviyede okuldan ayrılan öğrencilere, kaldıkları yerden tekrar devam etme imkanı sağlamaktadır.	0	0	0	0	0
Altyapı Durumu						
50.	Okulumuzda laboratuvarlar (bilgisayar,elektronik, donanım, ağ vb.) yeterlidir.	0	0	0	0	0
51.	Okulumuzda laboratuvar araç-gereç ve materyalleri yeterlidir.	0	0	0	0	0
52.	Okulumuzda yazılım ve donanım yeterlidir.	0	0	0	0	0
53.	Okulumuzun teknik donanımı (TV, bilgisayar, projeksiyon makinası) yeterli koşullara sahiptir.	0	0	0	0	0
54.	Okulumuzda sınıflar öğrencilerin serbest çalışabileceği ve bireysel uygulamalar yapabileceği şekilde düzenlenmiştir.	0	0	0	0	0
55.	Okulumuzda sınıflarda öğrencilerin faydalabileceği yazılı ve görsel kaynakları içeren kütüphaneler bulunmaktadır.	0	0	0	0	0
Modüller						
56.	Modüllerin amaç ifadeleri açık ve anlaşılır niteliktedir.	0	0	0	0	0
57.	Modüllerde amaca ulaşmak için seçilen koşullar ve standartlar doğru belirlenmiştir.	0	0	0	0	0
58.	Modüllerde hedeflenen amaçlara ulaşabilmek için iş anlamlı parçalara bölünmüştür.	0	0	0	0	0
59.	Modüllerde içerik öğrencinin bireysel çalışmasına imkan sağlayacak ölçüde geniştir ve iyi organize edilmiştir.	0	0	0	0	0
60.	Modüller açık ve anlaşılır bir dille yazılmıştır.	0	0	0	0	0
61.	Modüller öğrencinin bireysel çalışmasına imkan sağlayan yönlendirici işaretleri ve açıklayıcı bilgileri içermektedir.	0	0	0	0	0
62.	Modülün giriş bölümünde bireye mesleki beceri yönünden neler kazandıracağı açıkça ifade edilmiştir.	0	0	0	0	0
63.	Modüller öğrencileri yönlendirici ve güdüleyici niteliktedir.	0	0	0	0	0
64.	Modüller becerilerin kazandırılabilmesi için yeterli miktarda uygulama faaliyeti içermektedir.	0	0	0	0	0
65.	Modül içerikleri farklı ve çok sayıda örnekle desteklenmiştir.	0	0	0	0	0
66.	Modüller öğrenciye işbirliği yapma, grup çalışması yapma, sorumluluk alma fırsatı vermektedir.	0	0	0	0	0
67.	Modüller öğrencinin yönlendirmeler doğrultusunda araştırma yapmasına,proje hazırlamasına ve sunmasına olanak sağlamaktadır.	0	0	0	0	0
68.	Modüller öğrenciye kendi hızında ilerleme imkanı sunmaktadır	0	0	0	0	0
69.	Modüller öğrenciye kendi kendini değerlendirme fırsatı vermektedir.	0	0	0	0	0
70.	Öğretmenler ve öğrenciler modülleri elde etmede herhangi bir problem yaşamamaktadır.	0	0	0	0	0
71.	Modüllerin tümünün hazır olması durumunda öğretim süreci kolaylaşacaktır.	0	0	0	0	0
Öğrenciler						
72.	Öğrenciler modülleri kullanarak bağımsız çalışmayı becerilebilirler.	0	0	0	0	0
73.	Program öğrenci seviyesine uygundur.	0	0	0	0	0

İFADELER/GÖRÜŞLER					
	Kesinlikle Katılıyorum	Katılıyorum	Kararsızım	Katılmıyorum	Kesinlikle Katılmıyorum
74. Öğrencilerin okuma ve anlama becerileri modülleri bağımsız olarak takip edebilmelerinde yeterlidir.	<input type="radio"/>	<input type="radio"/>	<input type="radio"/>	<input type="radio"/>	<input type="radio"/>
75. Program engelli öğrencilerinde rahatca takip etmelerini sağlayacak eğitsel materyalleri içermektedir.	<input type="radio"/>	<input type="radio"/>	<input type="radio"/>	<input type="radio"/>	<input type="radio"/>
76. Öğrenciler programda nasıl öğrenmeleri gerektiği hakkında bilgi sahibidirler.	<input type="radio"/>	<input type="radio"/>	<input type="radio"/>	<input type="radio"/>	<input type="radio"/>
77. Öğrenciler programın gerektirdiği çalışmalarını yürütebilmek için yeterli zamana ve imkanlara sahiptirler.	<input type="radio"/>	<input type="radio"/>	<input type="radio"/>	<input type="radio"/>	<input type="radio"/>

Bölüm 3:

Yeni Programın Uygulanmasına İlişkin Görüşler

Bu bölümde yer alan ifadelerde görüşünüzü yuvarlak kutucukları doldurarak belirtebilirsiniz. (Lütfen her ifade için bir kutucuk doldurunuz)

Derslerinizi işlerken aşağıdaki öğretim yöntem ve tekniklerinden hangilerini, hangi sıklıkla kullanıyorsunuz?					
	Her Zaman	Sık Sık	Bazen	Nadiren	Hiçbir zaman
a) Düz anlatım	<input type="radio"/>	<input type="radio"/>	<input type="radio"/>	<input type="radio"/>	<input type="radio"/>
b) Soru-cevap	<input type="radio"/>	<input type="radio"/>	<input type="radio"/>	<input type="radio"/>	<input type="radio"/>
c) Tartışma	<input type="radio"/>	<input type="radio"/>	<input type="radio"/>	<input type="radio"/>	<input type="radio"/>
d) Gösteri	<input type="radio"/>	<input type="radio"/>	<input type="radio"/>	<input type="radio"/>	<input type="radio"/>
e) Grup çalışması	<input type="radio"/>	<input type="radio"/>	<input type="radio"/>	<input type="radio"/>	<input type="radio"/>
f) Proje çalışması	<input type="radio"/>	<input type="radio"/>	<input type="radio"/>	<input type="radio"/>	<input type="radio"/>
g) Problem çözme	<input type="radio"/>	<input type="radio"/>	<input type="radio"/>	<input type="radio"/>	<input type="radio"/>
h) Gözlem gezisi	<input type="radio"/>	<input type="radio"/>	<input type="radio"/>	<input type="radio"/>	<input type="radio"/>
i) Rol oynama	<input type="radio"/>	<input type="radio"/>	<input type="radio"/>	<input type="radio"/>	<input type="radio"/>
j) Örnek olay incelemesi	<input type="radio"/>	<input type="radio"/>	<input type="radio"/>	<input type="radio"/>	<input type="radio"/>
k) Beyin fırtınası	<input type="radio"/>	<input type="radio"/>	<input type="radio"/>	<input type="radio"/>	<input type="radio"/>
l) Benzetişim	<input type="radio"/>	<input type="radio"/>	<input type="radio"/>	<input type="radio"/>	<input type="radio"/>
m) Tartışma	<input type="radio"/>	<input type="radio"/>	<input type="radio"/>	<input type="radio"/>	<input type="radio"/>
n) Görüşme	<input type="radio"/>	<input type="radio"/>	<input type="radio"/>	<input type="radio"/>	<input type="radio"/>

Öğrenci başarısını değerlendirirken aşağıdaki ölçme araç ve yöntemlerinden hangilerini, hangi sıklıkla kullanıyorsunuz?					
	Her Zaman	Sık Sık	Bazen	Nadiren	Hiçbir zaman
a) Modül objektif testler	<input type="radio"/>	<input type="radio"/>	<input type="radio"/>	<input type="radio"/>	<input type="radio"/>
b) Modül performans testi	<input type="radio"/>	<input type="radio"/>	<input type="radio"/>	<input type="radio"/>	<input type="radio"/>
c) Performans ödevleri	<input type="radio"/>	<input type="radio"/>	<input type="radio"/>	<input type="radio"/>	<input type="radio"/>
d) Proje ödevleri	<input type="radio"/>	<input type="radio"/>	<input type="radio"/>	<input type="radio"/>	<input type="radio"/>
e) Öğrenci ürün dosyaları	<input type="radio"/>	<input type="radio"/>	<input type="radio"/>	<input type="radio"/>	<input type="radio"/>
f) Dereceli puanlama anahtarları	<input type="radio"/>	<input type="radio"/>	<input type="radio"/>	<input type="radio"/>	<input type="radio"/>
g) Derecelendirme ölçekleri	<input type="radio"/>	<input type="radio"/>	<input type="radio"/>	<input type="radio"/>	<input type="radio"/>
h) Kontrol listeleri	<input type="radio"/>	<input type="radio"/>	<input type="radio"/>	<input type="radio"/>	<input type="radio"/>
i) Kavram haritaları	<input type="radio"/>	<input type="radio"/>	<input type="radio"/>	<input type="radio"/>	<input type="radio"/>

Öğrenci başarısını değerlendirirken aşağıdaki ölçme araç ve yöntemlerinden hangilerini, hangi sıklıkla kullanıyorsunuz?	Her Zaman	Sık Sık	Bazen	Nadiren	Hiçbir zaman
i) Açık uçlu sorular	<input type="radio"/>	<input type="radio"/>	<input type="radio"/>	<input type="radio"/>	<input type="radio"/>
j) Kısa cevaplı sorular	<input type="radio"/>	<input type="radio"/>	<input type="radio"/>	<input type="radio"/>	<input type="radio"/>
k) Çoktan seçmeli sorular	<input type="radio"/>	<input type="radio"/>	<input type="radio"/>	<input type="radio"/>	<input type="radio"/>
l) Eşleştirmeli sorular	<input type="radio"/>	<input type="radio"/>	<input type="radio"/>	<input type="radio"/>	<input type="radio"/>
m) Doğru-yanlış soruları	<input type="radio"/>	<input type="radio"/>	<input type="radio"/>	<input type="radio"/>	<input type="radio"/>

Yeni Modüler Bilişim Teknolojileri Müfredatında öğretim sırasında karşılaşılan zorluklara katılma durumunuzu işaretleyiniz.	Kesinlikle Katılıyorum	Katılıyorum	Kararsızım	Katılmıyorum	Kesinlikle Katılmıyorum
Sınıflardaki öğrenci sayısının fazla olması	<input type="radio"/>	<input type="radio"/>	<input type="radio"/>	<input type="radio"/>	<input type="radio"/>
Programın yoğun olması nedeniyle uygulamalara yeterli zaman ayrılamaması	<input type="radio"/>	<input type="radio"/>	<input type="radio"/>	<input type="radio"/>	<input type="radio"/>
Konuların araç-gereç eksikliğinden dolayı teorik olarak anlatılması	<input type="radio"/>	<input type="radio"/>	<input type="radio"/>	<input type="radio"/>	<input type="radio"/>
Konularla ilgili film, slayt, maket, vb. gösterilememesi	<input type="radio"/>	<input type="radio"/>	<input type="radio"/>	<input type="radio"/>	<input type="radio"/>
Konularla ilgili güncel yazılım eksikliği	<input type="radio"/>	<input type="radio"/>	<input type="radio"/>	<input type="radio"/>	<input type="radio"/>
Ders konularını iş hayatıyla bağlantısını kurmada zorluklar yaşanması	<input type="radio"/>	<input type="radio"/>	<input type="radio"/>	<input type="radio"/>	<input type="radio"/>
Çok sayıda öğrenci ile uygulama yapılması	<input type="radio"/>	<input type="radio"/>	<input type="radio"/>	<input type="radio"/>	<input type="radio"/>
Derslerde öğrencinin bireysel ve grup çalışmaları ile aktif olmasının sağlanamaması	<input type="radio"/>	<input type="radio"/>	<input type="radio"/>	<input type="radio"/>	<input type="radio"/>
Ders modüllerinin yetersiz olmasından dolayı ilave kaynaklara ihtiyaç duyulması	<input type="radio"/>	<input type="radio"/>	<input type="radio"/>	<input type="radio"/>	<input type="radio"/>
Ders modüllerinden halen hazır olmayanların bulunması	<input type="radio"/>	<input type="radio"/>	<input type="radio"/>	<input type="radio"/>	<input type="radio"/>
Ders modüllerine erişim olanağının kısıtlı olması	<input type="radio"/>	<input type="radio"/>	<input type="radio"/>	<input type="radio"/>	<input type="radio"/>
Programın öğretmen ve laboratuvar kılavuz kitabının bulunmaması	<input type="radio"/>	<input type="radio"/>	<input type="radio"/>	<input type="radio"/>	<input type="radio"/>
Laboratuvar araç-gereçlerini kullanmadaki bilgi yetersizliği	<input type="radio"/>	<input type="radio"/>	<input type="radio"/>	<input type="radio"/>	<input type="radio"/>
Laboratuvar araç-gereç eksiklikleri	<input type="radio"/>	<input type="radio"/>	<input type="radio"/>	<input type="radio"/>	<input type="radio"/>
Laboratuvar derslerinde öğretmen başına düşen öğrenci sayısındaki fazlalık	<input type="radio"/>	<input type="radio"/>	<input type="radio"/>	<input type="radio"/>	<input type="radio"/>

Yukarıdaki ifadelere ilave etmek istedikleriniz varsa lütfen yazınız

.....

.....

.....

Appendix J : Teachers Questionnaire (English)

Evaluation Questionnaire of Vocational High Schools' Information Technology Area Curriculum for teachers

Dear Colleagues,

The aim of this questionnaire is to evaluate the new modular Information Technologies program with the intention of detecting the effective factors in implementation. As the answers that you will give to the questions below will play an important role in shaping the program in upcoming years, it is of utmost importance that you maintain your objectivity and mark your answers accordingly.

As the answers will be used with academic intentions, you do not have to write your names. Thank you for your cooperation.

Kader BIÇER
METU Educational Sciences
Master Student

Assoc. Prof. Dr. Ercan KIRAZ
METU
Educational Sciences Department

Part 1:

Demographic Information

1. Sex: W M
2. Age : 20–25 26–30 31–35 36–40 41–45 46 and above
3. Name of the Graduated University
4. Name of the Faculty.....
5. Name of the Department
6. Location of the School.....
7. Type of the school
 Voc. High Sch. Ana. Voc. High Sch Tech. High Sch. Ana. Tech High Sch
8. General Directorate of the School
 DG of Commerce and Tourism Education
 DG of Technical Education for Boys
 DG of Technical Education for Girls
9. Year of Experience
 1–5 6–10 11–15 16–20 21–24 25 and above
10. Number of the required IT teacher in your school....., current number
11. Teacher Status
 Expert permanent Permanent Intern Permanent Contract Personnel
12. Work load (class hours per week)
13. Name of Departments
 Computer Technical Service
 Database Programming
 Web Programming
 Network Management
14. Attendance at in-service training programs
 None Once Twice More than two times
15. Evaluation of in-service training programs
 Very helpful Moderately Not helpful
16. Other opinions on in-service training programs
.....
.....
.....

Part 2:
Program Principles

İFADELER/GÖRÜŞLER	Strongly Agree	Agree	Neither Agree Nor Disagree	Disagree	Strongly Disagree
Teachers					
1. I have required information on the objectives and implementation of program	<input type="radio"/>	<input type="radio"/>	<input type="radio"/>	<input type="radio"/>	<input type="radio"/>
2.The introduction seminars and meetings of program were sufficient	<input type="radio"/>	<input type="radio"/>	<input type="radio"/>	<input type="radio"/>	<input type="radio"/>
3.Program is satisfactory in terms of applicability and practicability	<input type="radio"/>	<input type="radio"/>	<input type="radio"/>	<input type="radio"/>	<input type="radio"/>
4.I am the master of program content	<input type="radio"/>	<input type="radio"/>	<input type="radio"/>	<input type="radio"/>	<input type="radio"/>
5.I am the master of program application activities	<input type="radio"/>	<input type="radio"/>	<input type="radio"/>	<input type="radio"/>	<input type="radio"/>
6.I need in-service teacher training on new topics of program	<input type="radio"/>	<input type="radio"/>	<input type="radio"/>	<input type="radio"/>	<input type="radio"/>
7.Program supplies the necessary resources and materials to the teachers	<input type="radio"/>	<input type="radio"/>	<input type="radio"/>	<input type="radio"/>	<input type="radio"/>
8.I can solve problems related to program with the meetings in my school	<input type="radio"/>	<input type="radio"/>	<input type="radio"/>	<input type="radio"/>	<input type="radio"/>
9.Program have problems that can not be solved by the support of school	<input type="radio"/>	<input type="radio"/>	<input type="radio"/>	<input type="radio"/>	<input type="radio"/>
10.New program was needed and the results will be positive	<input type="radio"/>	<input type="radio"/>	<input type="radio"/>	<input type="radio"/>	<input type="radio"/>
Program Objectives					
11. The objectives of the program are parallel to the innovations of IT global sector	<input type="radio"/>	<input type="radio"/>	<input type="radio"/>	<input type="radio"/>	<input type="radio"/>
12. The objectives of the program meets the needs of IT national sector	<input type="radio"/>	<input type="radio"/>	<input type="radio"/>	<input type="radio"/>	<input type="radio"/>
13. The objectives of the program are responsive to the local industry needs	<input type="radio"/>	<input type="radio"/>	<input type="radio"/>	<input type="radio"/>	<input type="radio"/>
14. The objectives of the program are responsive consider the requirements and expectations of local community	<input type="radio"/>	<input type="radio"/>	<input type="radio"/>	<input type="radio"/>	<input type="radio"/>
15. The objectives of the program can be formed up to the individual students needs and interests.	<input type="radio"/>	<input type="radio"/>	<input type="radio"/>	<input type="radio"/>	<input type="radio"/>
16. The objectives of the program precisely cover the needed skills of occupations	<input type="radio"/>	<input type="radio"/>	<input type="radio"/>	<input type="radio"/>	<input type="radio"/>
Content					
17. The content is adequate to actualize the objectives of the program	<input type="radio"/>	<input type="radio"/>	<input type="radio"/>	<input type="radio"/>	<input type="radio"/>
18. The content includes all the necessary topics of IT area	<input type="radio"/>	<input type="radio"/>	<input type="radio"/>	<input type="radio"/>	<input type="radio"/>
19. The content is comprised of occupational skills that my school claims.	<input type="radio"/>	<input type="radio"/>	<input type="radio"/>	<input type="radio"/>	<input type="radio"/>
20. The content is based on student centred approach	<input type="radio"/>	<input type="radio"/>	<input type="radio"/>	<input type="radio"/>	<input type="radio"/>
21. 10 th grade course content is sufficient in achieving basic skills of IT area	<input type="radio"/>	<input type="radio"/>	<input type="radio"/>	<input type="radio"/>	<input type="radio"/>
22. The departments are inline with the occupational profiles of IT area	<input type="radio"/>	<input type="radio"/>	<input type="radio"/>	<input type="radio"/>	<input type="radio"/>
23. 11 th and 12 th grade course content is sufficient in achieving specific skills of departments	<input type="radio"/>	<input type="radio"/>	<input type="radio"/>	<input type="radio"/>	<input type="radio"/>
24. The content of courses related to generic skills such as adaptability to work environment, good communication etc. is satisfactory	<input type="radio"/>	<input type="radio"/>	<input type="radio"/>	<input type="radio"/>	<input type="radio"/>
25. The connection among modules within a course is well constructed	<input type="radio"/>	<input type="radio"/>	<input type="radio"/>	<input type="radio"/>	<input type="radio"/>
26. Modules are prerequisite of each other	<input type="radio"/>	<input type="radio"/>	<input type="radio"/>	<input type="radio"/>	<input type="radio"/>

İFADELER/GÖRÜŞLER	Strongly Agree	Agree	Neither Agree Nor Disagree	Disagree	Strongly Disagree
Program Implementation					
27.Course and module contents have a structure that can be updateable parallel to the improvements in technology and science	0	0	0	0	0
28.Program is adaptable to the local educational needs	0	0	0	0	0
29.Program is adapted up to the local labour market needs in our schools environment	0	0	0	0	0
30.Program is adapted up to the local community needs in our schools environment	0	0	0	0	0
31.Program is adapted up to the students' needs, interests and preferences in our school	0	0	0	0	0
32.Program is adapted up to the students' current qualifications in our school	0	0	0	0	0
33.Program is adapted up to the each students' progress rate in our school	0	0	0	0	0
34.Program is adapted up to the students' background experiences and learning methods in our school	0	0	0	0	0
35.Local labour market requirements in our school distinct are considered in module selection and time allocation	0	0	0	0	0
36.Teachers' and Students' characteristics in our school are considered in module selection and time allocation	0	0	0	0	0
37.Our schools' infrastructure and resource circumstances are considered in module selection and time allocation	0	0	0	0	0
38.A committee is formed in our school that constituted of administrators, teachers and sector representatives for module selection and time allocation	0	0	0	0	0
39.Instructional activities are progressing in cooperation with IT sector	0	0	0	0	0
40.The connections between teachers and IT sector are well established	0	0	0	0	0
41.The workplace training opportunities for students are wide in IT sector	0	0	0	0	0
42.The duration of workplace training is satisfactory for students	0	0	0	0	0
43.Program offers the students to follow their individual way by selecting among courses	0	0	0	0	0
44.Program offers the students to follow their individual way by selecting among modules	0	0	0	0	0
45.Program offers the students to progress on their own rate and accordingly graduation in different times	0	0	0	0	0
46.Program offers the transactions between areas	0	0	0	0	0
47.Program offers the transactions between departments	0	0	0	0	0
48.Program offers certificates to the students exit the system early	0	0	0	0	0
49.Program offers the opportunity of returning back to the students exit the system early	0	0	0	0	0
Infrastructures					
50.The laboratories (computer, electronics, hardware, network etc) are sufficient in our school	0	0	0	0	0
51.The equipments and materials of laboratories are sufficient in our school	0	0	0	0	0
52.The hardware and software are sufficient in our school	0	0	0	0	0

İFADELER/GÖRÜŞLER	Strongly Agree	Agree	Neither Agree Nor Disagree	Disagree	Strongly Disagree
53.The technical facilities (TV, computer, projection etc) are sufficient in our school	○	○	○	○	○
54.The classrooms of our school are organized in a way that the students can study individually	○	○	○	○	○
55.The classrooms of our school have the libraries that contain written and visual resources	○	○	○	○	○
Modules					
56.The objective statements of modules are clear and easily comprehensible	○	○	○	○	○
57.The selected conditions and standards are well defined within the modules	○	○	○	○	○
58.The application activities are split into semantic parts in the modules	○	○	○	○	○
59.The content of the modules organized in way that support the students' individual progress	○	○	○	○	○
60.The statement in the modules are clear and easily comprehensible	○	○	○	○	○
61.Modules include the guidelines and explanations for students individual study	○	○	○	○	○
62.Modules include the initiation statements that explains the occupational advantages to students	○	○	○	○	○
63.Modules have the qualification to guide and motivate the students	○	○	○	○	○
64.Modules include plenty of application activities to achieve the occupational skills	○	○	○	○	○
65.The content of the modules are supported with a variety of examples	○	○	○	○	○
66.Modules offer students the opportunities of collaboration, group work and taking responsibility	○	○	○	○	○
67.Modules offer students the opportunities of research, preparation of project work and presentation	○	○	○	○	○
68.Modules offer students the opportunity of progressing in their own rates	○	○	○	○	○
69.Modules offer students the opportunity of self assessment	○	○	○	○	○
70.The teachers and students can easily handle the modules	○	○	○	○	○
71.The Instructional processes will be easier if all the modules are ready	○	○	○	○	○
Students					
72.The students have the ability of studying individually by using the modules	○	○	○	○	○
73.Program is appropriate for students level	○	○	○	○	○
74.The students reading and comprehending abilities are proper to follow the modules individually	○	○	○	○	○
75.Program includes the materials for disadvantaged students to follow the modules individually	○	○	○	○	○
76.The students are informed on how to learn with this program	○	○	○	○	○
77.The students have enough time and opportunities to perform the required studies	○	○	○	○	○

Part 3:

Program Implementation

Teaching Methods and Approaches	Always	Often	Sometimes	Rarely	Never
a) Lecturing	<input type="radio"/>	<input type="radio"/>	<input type="radio"/>	<input type="radio"/>	<input type="radio"/>
b) Questioning	<input type="radio"/>	<input type="radio"/>	<input type="radio"/>	<input type="radio"/>	<input type="radio"/>
c) Discussion	<input type="radio"/>	<input type="radio"/>	<input type="radio"/>	<input type="radio"/>	<input type="radio"/>
d) Demonstration	<input type="radio"/>	<input type="radio"/>	<input type="radio"/>	<input type="radio"/>	<input type="radio"/>
e) Group work	<input type="radio"/>	<input type="radio"/>	<input type="radio"/>	<input type="radio"/>	<input type="radio"/>
f) Proje çalışması	<input type="radio"/>	<input type="radio"/>	<input type="radio"/>	<input type="radio"/>	<input type="radio"/>
g) Project work	<input type="radio"/>	<input type="radio"/>	<input type="radio"/>	<input type="radio"/>	<input type="radio"/>
h) Field trip	<input type="radio"/>	<input type="radio"/>	<input type="radio"/>	<input type="radio"/>	<input type="radio"/>
i) Role playing	<input type="radio"/>	<input type="radio"/>	<input type="radio"/>	<input type="radio"/>	<input type="radio"/>
ı) Case study	<input type="radio"/>	<input type="radio"/>	<input type="radio"/>	<input type="radio"/>	<input type="radio"/>
j) Brainstorming	<input type="radio"/>	<input type="radio"/>	<input type="radio"/>	<input type="radio"/>	<input type="radio"/>
k) Simulation	<input type="radio"/>	<input type="radio"/>	<input type="radio"/>	<input type="radio"/>	<input type="radio"/>
m) Interviewing	<input type="radio"/>	<input type="radio"/>	<input type="radio"/>	<input type="radio"/>	<input type="radio"/>

Assessment and Measurement Techniques	Always	Often	Sometimes	Rarely	Never
a) Module objective test	<input type="radio"/>	<input type="radio"/>	<input type="radio"/>	<input type="radio"/>	<input type="radio"/>
b) Module performance test	<input type="radio"/>	<input type="radio"/>	<input type="radio"/>	<input type="radio"/>	<input type="radio"/>
c) Performance task	<input type="radio"/>	<input type="radio"/>	<input type="radio"/>	<input type="radio"/>	<input type="radio"/>
d) Project work	<input type="radio"/>	<input type="radio"/>	<input type="radio"/>	<input type="radio"/>	<input type="radio"/>
e) Portfolio	<input type="radio"/>	<input type="radio"/>	<input type="radio"/>	<input type="radio"/>	<input type="radio"/>
f) Graded key	<input type="radio"/>	<input type="radio"/>	<input type="radio"/>	<input type="radio"/>	<input type="radio"/>
g) Check list	<input type="radio"/>	<input type="radio"/>	<input type="radio"/>	<input type="radio"/>	<input type="radio"/>
ı) Concept map	<input type="radio"/>	<input type="radio"/>	<input type="radio"/>	<input type="radio"/>	<input type="radio"/>
i) Open response item	<input type="radio"/>	<input type="radio"/>	<input type="radio"/>	<input type="radio"/>	<input type="radio"/>
j) Short answer item	<input type="radio"/>	<input type="radio"/>	<input type="radio"/>	<input type="radio"/>	<input type="radio"/>
k) Mutiple choice item	<input type="radio"/>	<input type="radio"/>	<input type="radio"/>	<input type="radio"/>	<input type="radio"/>
l) Matching item	<input type="radio"/>	<input type="radio"/>	<input type="radio"/>	<input type="radio"/>	<input type="radio"/>
m) True-False item	<input type="radio"/>	<input type="radio"/>	<input type="radio"/>	<input type="radio"/>	<input type="radio"/>

Problems faced during instruction	Strongly Agree	Agree	Neither Agree Nor Disagree	Disagree	Strongly Disagree
Crowded classrooms	<input type="radio"/>	<input type="radio"/>	<input type="radio"/>	<input type="radio"/>	<input type="radio"/>
Insufficient time allocation for applications because of heavily loaded program	<input type="radio"/>	<input type="radio"/>	<input type="radio"/>	<input type="radio"/>	<input type="radio"/>
Theoretical instruction because of insufficient equipments	<input type="radio"/>	<input type="radio"/>	<input type="radio"/>	<input type="radio"/>	<input type="radio"/>

Problems faced during instruction	Strongly Agree	Agree	Neither Agree Nor Disagree	Disagree	Strongly Disagree
Insufficient visual instruction because of deficiencies in materials such as films, slides etc	<input type="radio"/>	<input type="radio"/>	<input type="radio"/>	<input type="radio"/>	<input type="radio"/>
Insufficient updated software	<input type="radio"/>	<input type="radio"/>	<input type="radio"/>	<input type="radio"/>	<input type="radio"/>
Difficulties in connecting topics to the real life work environment	<input type="radio"/>	<input type="radio"/>	<input type="radio"/>	<input type="radio"/>	<input type="radio"/>
Performing applications with a crowded student group	<input type="radio"/>	<input type="radio"/>	<input type="radio"/>	<input type="radio"/>	<input type="radio"/>
Inability to activate to students during lessons	<input type="radio"/>	<input type="radio"/>	<input type="radio"/>	<input type="radio"/>	<input type="radio"/>
Necessity of additional resources because of insufficient modules	<input type="radio"/>	<input type="radio"/>	<input type="radio"/>	<input type="radio"/>	<input type="radio"/>
Currently not prepared modules	<input type="radio"/>	<input type="radio"/>	<input type="radio"/>	<input type="radio"/>	<input type="radio"/>
Insufficient access opportunities to the modules	<input type="radio"/>	<input type="radio"/>	<input type="radio"/>	<input type="radio"/>	<input type="radio"/>
Not supported teacher and laboratory guide books	<input type="radio"/>	<input type="radio"/>	<input type="radio"/>	<input type="radio"/>	<input type="radio"/>
Insufficient information on usage of laboratory equipments	<input type="radio"/>	<input type="radio"/>	<input type="radio"/>	<input type="radio"/>	<input type="radio"/>
Insufficient laboratory equipments	<input type="radio"/>	<input type="radio"/>	<input type="radio"/>	<input type="radio"/>	<input type="radio"/>
Crowded student groups for each teacher during laboratory hours	<input type="radio"/>	<input type="radio"/>	<input type="radio"/>	<input type="radio"/>	<input type="radio"/>

Appendix K: Students Questionnaire (Turkish)

Meslek Liseleri Modüler Bilişim Teknolojileri Programı Öğrenci Etki Değerlendirme Anketi

Sevgili Bilişim Teknolojileri Alanı 11. ve 12. sınıf öğrencileri,

Bu anket yeni modüler bilişim teknolojileri öğretim programının değerlendirmesini yapmak ve uygulamada etkili olan faktörleri tespit etmek amacıyla gerçekleştirilen akademik bir çalışmada kullanılmak üzere hazırlanmıştır. Soruları yanıtlarken göstereceğiniz dikkat, samimiyet ve sabır, var olan durumun olduğu gibi ortaya konulması açısından önemlidir. Bu nedenle lütfen formdaki hiçbir soruyu yanıtızsız bırakmayınız.

Yanıtlarınızın akademik amaçlarla kullanılacağı bu ankete isimlerinizi yazmanız gerekmemektedir. Katkılarınızdan ötürü teşekkür eder, çalışmalarınızda başarılar dileriz.

Kader BİÇER
ODTÜ Eğitim Fakültesi,
Eğitim Bilimleri Bölümü
Yüksek Lisans Öğrencisi

Doç. Dr. Ercan KİRAZ
ODTÜ Eğitim Fakültesi,
Eğitim Bilimleri Bölümü

Bölüm 1:

Kişisel Bilgiler

Bu bölümde kişisel bilgilerinize ilişkin sorular yer almaktadır.

15. Cinsiyetiniz: K E

16. Okulunuzun Adı:

17. Okulunuzun Türü:

Anadolu Teknik Lise Teknik Lise Anadolu Meslek Lisesi Meslek Lisesi

18. Eğitim aldığınız dalın adı:

Bilgisayar Teknik Servisi
 Veri Tabanı Programcılığı
 Web Programcılığı
 Ağ İşletmenliği

Bölüm 2:

Yeni Programın Uygulanmasına İlişkin Görüşler

Bu bölümde yer alan ifadelerde görüşünüzü yuvarlak kutucukları doldurarak belirtebilirsiniz. (Lütfen her ifade için bir kutucuk doldurunuz)

İFADELER/GÖRÜŞLER	Kesinlikle Katılmıyorum	Katılmıyorum	Kararsızım	Katılmıyorum	Kesinlikle Katılmıyorum
Bilişim Teknolojileri Alan Programı					
2. Derslerin alanımla ilgili ihtiyaç duyduğum tüm bilgileri içerdiğini düşünüyorum.	<input type="radio"/>	<input type="radio"/>	<input type="radio"/>	<input type="radio"/>	<input type="radio"/>
3. Alanımda kendimi yeterli hissediyorum.	<input type="radio"/>	<input type="radio"/>	<input type="radio"/>	<input type="radio"/>	<input type="radio"/>
4. Öğrenim gördüğüm dal kendi tercihimdi.	<input type="radio"/>	<input type="radio"/>	<input type="radio"/>	<input type="radio"/>	<input type="radio"/>
5. Derslere modülleri takip ederek kendi kendime çalışabiliyorum.	<input type="radio"/>	<input type="radio"/>	<input type="radio"/>	<input type="radio"/>	<input type="radio"/>
6. Modülleri ancak öğretmen konuyu anlattıktan sonra anlayabiliyorum.	<input type="radio"/>	<input type="radio"/>	<input type="radio"/>	<input type="radio"/>	<input type="radio"/>

İFADELER/GÖRÜŞLER	Kesinlikle Katılıyorum	Katılıyorum	Kararsızım	Katılmıyorum	Kesinlikle Katılmıyorum
7. Konuyu modülden öğrenmektense, öğretmenin anlatmasını tercih ederim.	<input type="radio"/>	<input type="radio"/>	<input type="radio"/>	<input type="radio"/>	<input type="radio"/>
8. Modüllerdeki konular gayet açık ve anlaşılır.	<input type="radio"/>	<input type="radio"/>	<input type="radio"/>	<input type="radio"/>	<input type="radio"/>
9. Modüllerdeki uygulama faaliyetlerini adımları takip ederek kolaylıkla yapabiliyorum.	<input type="radio"/>	<input type="radio"/>	<input type="radio"/>	<input type="radio"/>	<input type="radio"/>
10. Modüllerdeki araştırma konularını kolaylıkla bulabiliyorum.	<input type="radio"/>	<input type="radio"/>	<input type="radio"/>	<input type="radio"/>	<input type="radio"/>
11. Modüller konu ile ilgili yeterli örneği içeriyor.	<input type="radio"/>	<input type="radio"/>	<input type="radio"/>	<input type="radio"/>	<input type="radio"/>
12. Modüller alanımızda güncel konuları içeriyor.	<input type="radio"/>	<input type="radio"/>	<input type="radio"/>	<input type="radio"/>	<input type="radio"/>
13. Modüllerdeki bilgiler ve uygulamalar yeterli düzeydedir.	<input type="radio"/>	<input type="radio"/>	<input type="radio"/>	<input type="radio"/>	<input type="radio"/>
14. Modülleri takip edebilmek için yeterli zaman bulabiliyorum.	<input type="radio"/>	<input type="radio"/>	<input type="radio"/>	<input type="radio"/>	<input type="radio"/>
15. Modüllere nasıl çalışmamız gerektiğini öğretmenlerimiz açıkladı.	<input type="radio"/>	<input type="radio"/>	<input type="radio"/>	<input type="radio"/>	<input type="radio"/>
16. Modüllerde bulunan değerlendirme soruları ile kendi kendimi değerlendirebiliyorum.	<input type="radio"/>	<input type="radio"/>	<input type="radio"/>	<input type="radio"/>	<input type="radio"/>
17. Modüllere kolaylıkla ulaşabiliyorum.	<input type="radio"/>	<input type="radio"/>	<input type="radio"/>	<input type="radio"/>	<input type="radio"/>
18. Derslerde ihtiyaç duyduğum kaynak kitaplara kolaylıkla ulaşabiliyorum.	<input type="radio"/>	<input type="radio"/>	<input type="radio"/>	<input type="radio"/>	<input type="radio"/>
19. Derslere aktif olarak katılıyorum.	<input type="radio"/>	<input type="radio"/>	<input type="radio"/>	<input type="radio"/>	<input type="radio"/>
20. Derslerde kendi kendimi ifade etme fırsatı bulabiliyorum.	<input type="radio"/>	<input type="radio"/>	<input type="radio"/>	<input type="radio"/>	<input type="radio"/>
21. Grup çalışmalarında görev almaktan hoşlanıyorum.	<input type="radio"/>	<input type="radio"/>	<input type="radio"/>	<input type="radio"/>	<input type="radio"/>
22. Derslerde güncel hayattan problemlere çözüm getiren projeler geliştiriyoruz.	<input type="radio"/>	<input type="radio"/>	<input type="radio"/>	<input type="radio"/>	<input type="radio"/>
23. Öğrenim görmekte olduğum alanın sektörle işbirliği içinde olduğunu düşünüyorum.	<input type="radio"/>	<input type="radio"/>	<input type="radio"/>	<input type="radio"/>	<input type="radio"/>
24. Sektörde alanımla ilgili staj imkanları geniştir.	<input type="radio"/>	<input type="radio"/>	<input type="radio"/>	<input type="radio"/>	<input type="radio"/>

Yukarıdaki ifadelere ilave etmek istedikleriniz varsa lütfen yazınız .

Appendix L : Students Questionnaire (English)

Evaluation Questionnaire of Vocational High Schools' Information Technology Area Curriculum for students

Dear Students,

The aim of this questionnaire is to evaluate the new modular Information Technologies program with the intention of detecting the effective factors in implementation. As the answers that you will give to the questions below will play an important role in shaping the program in upcoming years, it is of utmost importance that you maintain your objectivity and mark your answers accordingly.

As the answers will be used with academic intentions, you do not have to write your names. Thank you for your cooperation.

Kader BİÇER
METU Educational Sciences
Master Student

Assoc. Prof. Dr. Ercan KİRAZ
METU
Educational Sciences Department

Bölüm 1:

Demographic Information

1. Sex: W M
2. Name of the school:
3. Type of the school
 Voc. High Sch. Ana. Voc. High Sch Tech. High Sch. Ana. Tech High Sch
4. Name of Departments
 Computer Technical Service
 Database Programming
 Web Programming
 Network Management

Bölüm 2:

Program Implementation

İFADELER/GÖRÜŞLER	Strongly Agree	Agree	Neither Agree Nor Disagree	Disagree	Strongly Disagree
Bilişim Teknolojileri Alan Programı					
1. The courses include all required knowledge and skills	0	0	0	0	0
2. I feel myself sufficient in my occupational area	0	0	0	0	0
3. The branch was my choice	0	0	0	0	0
4. I can study the courses myself by following the modules	0	0	0	0	0
5. I can understand the topic after my teacher explain	0	0	0	0	0
6. I prefer learning the topic from teacher, instead of learning from module	0	0	0	0	0
7. The content of the modules are very clear and understandable	0	0	0	0	0
8. I can easily perform the application activities by following the steps	0	0	0	0	0
9. I can easily find research topics	0	0	0	0	0

İFADELER/GÖRÜŞLER	Strongly Agree	Agree	Neither Agree Nor Disagree	Disagree	Strongly Disagree
10. Modules include sufficient example related to topic	<input type="radio"/>	<input type="radio"/>	<input type="radio"/>	<input type="radio"/>	<input type="radio"/>
11. Modules include updated subjects	<input type="radio"/>	<input type="radio"/>	<input type="radio"/>	<input type="radio"/>	<input type="radio"/>
12. The knowledge and applications in the modules are satisfactory level	<input type="radio"/>	<input type="radio"/>	<input type="radio"/>	<input type="radio"/>	<input type="radio"/>
13. I can find enough time for following the modules	<input type="radio"/>	<input type="radio"/>	<input type="radio"/>	<input type="radio"/>	<input type="radio"/>
14. Our teachers explained us how to study modules	<input type="radio"/>	<input type="radio"/>	<input type="radio"/>	<input type="radio"/>	<input type="radio"/>
15. I can assess myself by using assessment questions in the modules	<input type="radio"/>	<input type="radio"/>	<input type="radio"/>	<input type="radio"/>	<input type="radio"/>
16. I can easily reach the modules	<input type="radio"/>	<input type="radio"/>	<input type="radio"/>	<input type="radio"/>	<input type="radio"/>
17. I can easily reach the resource books that I need	<input type="radio"/>	<input type="radio"/>	<input type="radio"/>	<input type="radio"/>	<input type="radio"/>
18. I participate the lessons actively	<input type="radio"/>	<input type="radio"/>	<input type="radio"/>	<input type="radio"/>	<input type="radio"/>
19. I can find the opportunity to express myself during lessons	<input type="radio"/>	<input type="radio"/>	<input type="radio"/>	<input type="radio"/>	<input type="radio"/>
20. I enjoy taking part into group works	<input type="radio"/>	<input type="radio"/>	<input type="radio"/>	<input type="radio"/>	<input type="radio"/>
21. We are developing projects which solves real life problems during lessons	<input type="radio"/>	<input type="radio"/>	<input type="radio"/>	<input type="radio"/>	<input type="radio"/>
22. I think that my occupational area collaborating with industry	<input type="radio"/>	<input type="radio"/>	<input type="radio"/>	<input type="radio"/>	<input type="radio"/>
23. Work place opportunities of my occupational area in labor market are broad	<input type="radio"/>	<input type="radio"/>	<input type="radio"/>	<input type="radio"/>	<input type="radio"/>

Appendix M: Curriculum Vitae

PERSONAL INFORMATION

Surname, Name: Biçer, Kader

Nationality: Turkish (TC)

Date and Place of Birth: 8 August 1980 , Amasya

Marital Status: Married

email: kaderyuksel@gmail.com

EDUCATION

Degree	Institution	Year of Graduation
BS	Gazi University, Technical Education Faculty, Electronics and Computer Education Department	2002
High School	Antalya Anatolian Vocational High School	1998

WORK EXPERIENCE

Year	Place	Enrollment
2005 December- 2008 May	Cumhuriyet Trade Vocational High School, Ankara	Computer Teacher
2005 November	Atatürk Primary School, Ankara	Computer Teacher
2004 September	Beypazarı Vocational High School, Ankara	Computer Teacher
2002 September	Ataturk Industrial Vocational High School, Antalya	Computer Teacher

FOREIGN LANGUAGES

Advanced English, Beginner German